

PLASTIC SURGERY

CATALOGUE



Plastic Surgery

1- Scissors	01-21
2- Needle Holders.....	21-25
3- Forceps.....	26-35
4- Hooks and Retractors.....	36-46
5- Aluminum Hand.....	47
6- Knives.....	48-50
7- Suction Instruments.....	51
8- Bone Instruments.....	52-60
9- Micro Vessel Clips and Clamps.....	61-63

Plastic Surgery Scissors

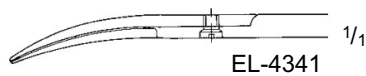
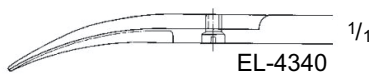
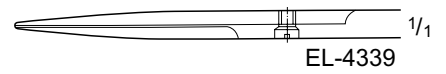
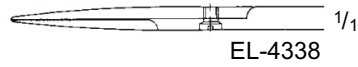
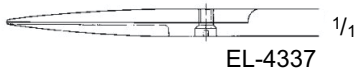
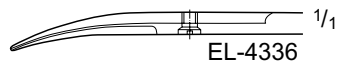
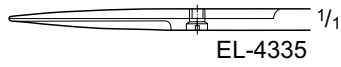
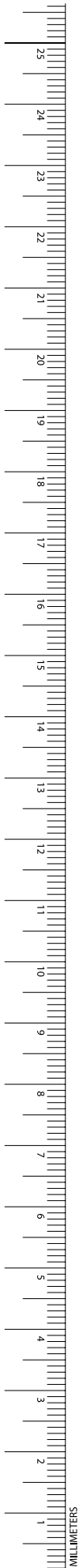

Iris Scissors, Delicate

Catalog Number	Tip	Blade	Handle	Length (in.)
EL-4335	S/S	STR	SQUARE	4 1/2
EL-4336	S/S	CVD	SQUARE	4 1/2
EL-4337	S/S	STR	ROUND	3 3/4
EL-4338	S/S	STR	ROUND	4 1/8
EL-4339	S/S	STR	ROUND	4 3/4
EL-4340	S/S	CVD	ROUND	3 3/4
EL-4341	S/S	CVD	ROUND	4 1/8
EL-4342	S/S	CVD	ROUND	4 3/4



Iris Scissors, Ribbon Handle

Catalog Number	Tip	Blade	Length (in.)
EL-4343	S/S	STR	4
EL-4344	S/S	CVD	4

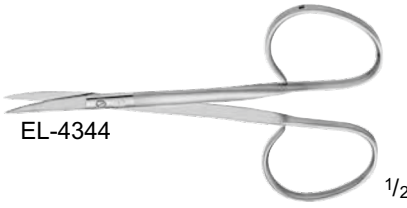

Suture Scissors

Catalog Number	Tip	Blade	Length (in.)
EL-4345	S/S	STR	4 3/4
EL-4346	S/S	STR	5 1/8
EL-4347	B/B	STR	5 1/8
EL-4348	B/B	CVD, DEL	4 3/4
EL-4349	S/S	CVD	4 3/4
EL-4350	S/S	CVD	5 1/8
EL-4351	B/B	CVD	5 1/8

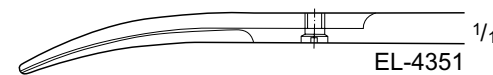
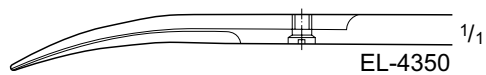
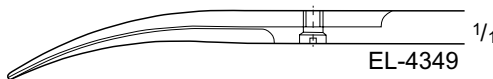
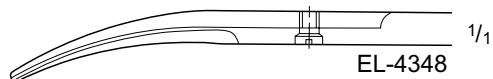
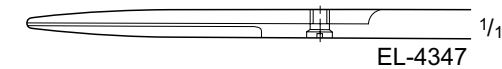
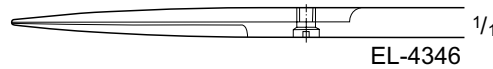
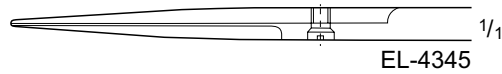

Plastic Surgery Scissors

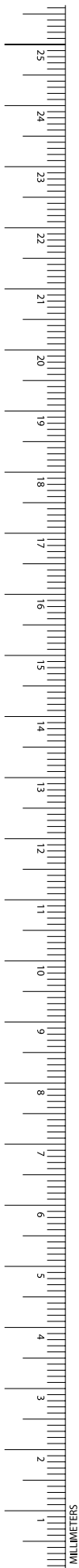

EL-4352-EL-4353

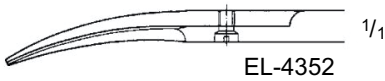

EL-4352



EL-4353

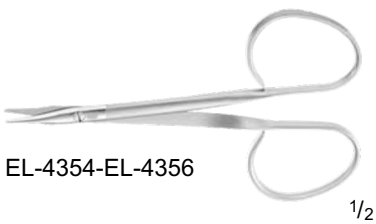

EL-4354-EL-4356

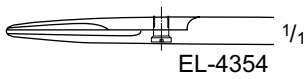

EL-4354

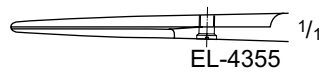

EL-4355

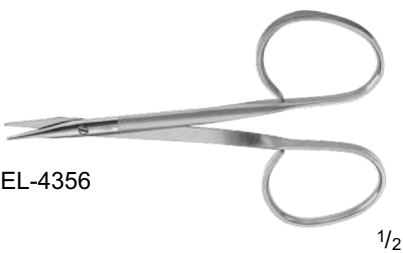

EL-4356

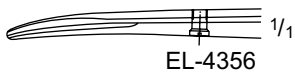

EL-4356

COTTLE-MASING Plastic Scissors

Catalog Number	Tip	Blade	Length (in.)
EL-4352	S/S	CVD	4 1/8
EL-4353	B/B	CVD	4 1/8

STEVENS Tenotomy Scissors

Catalog Number	Tip	Blade	Handle	Weight	Length (in.)
EL-4354	B/B	STR	RIBBON	LIGHT	3 3/4
EL-4355	B/B	STR	RIBBON	HEAVY	3 7/8
EL-4356	B/B	CVD	RIBBON	HEAVY	3 3/4

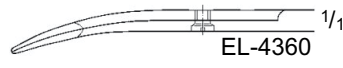
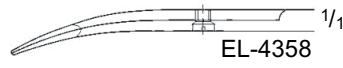
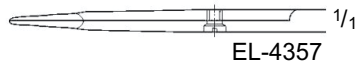
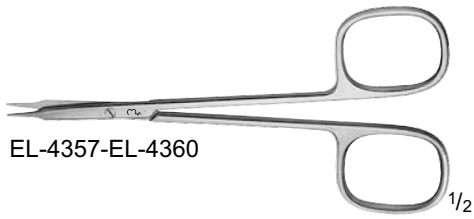

**STEVENS Tenotomy Scissors
(continued)**

Catalog Number	Tip	Blade	Handle	Length (in.)
EL-4357	S/S	STR	SQUARE	4 1/2
EL-4358	B/B	STR	SQUARE	4 1/2
EL-4359	S/S	CVD	SQUARE	4 1/2
EL-4360	B/B	CVD	SQUARE	4 1/2
EL-4361	S/S	STR	ROUND	4 1/4
EL-4362	B/B	STR	ROUND	4 1/4
EL-4363	B/B	STR	ROUND	5 3/4
EL-4364	S/S	CVD	ROUND	4 1/4
EL-4365	B/B	CVD	ROUND	4 1/4
EL-4366	B/B	CVD	ROUND	5 3/4

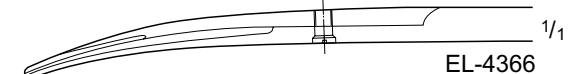
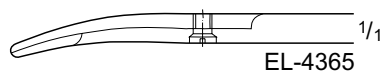
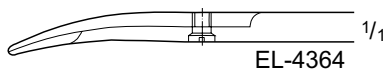
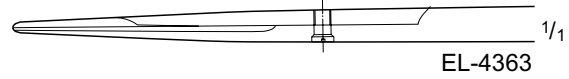
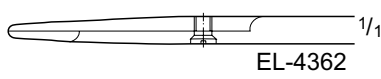
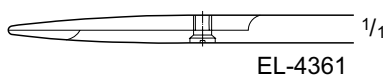
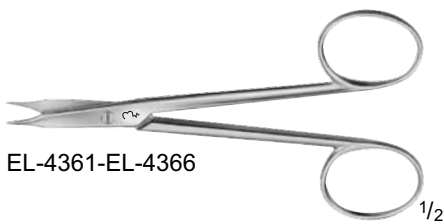

Plastic Surgery Scissors

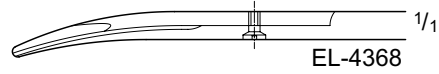
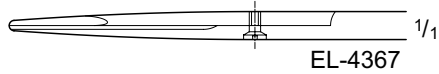
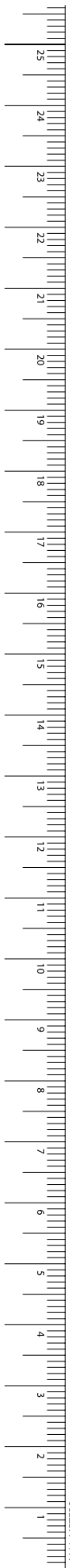

STEVENS Tenotomy Scissors, Delicate

Catalog Number	Tip	Blade	Length (in.)
EL-4367	B/B	STR	5
EL-4368	B/B	CVD	5

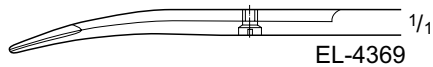

REYNOLDS-JAMESON Tenotomy Scissors, Delicate

Catalog Number	Tip	Blade	Handle	Length (in.)
EL-4369	B/B	CVD	SQUARE	5 1/2

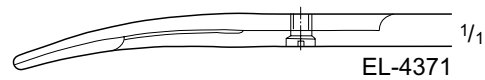
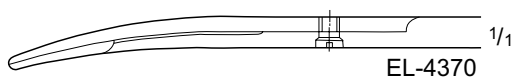

REYNOLDS Tenotomy Scissors, Delicate

Catalog Number	Tip	Blade	Length (in.)
EL-4370	B/B	CVD	5 3/4
EL-4371	B/B	CVD	6 7/8

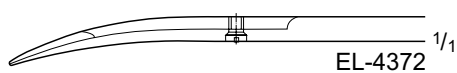
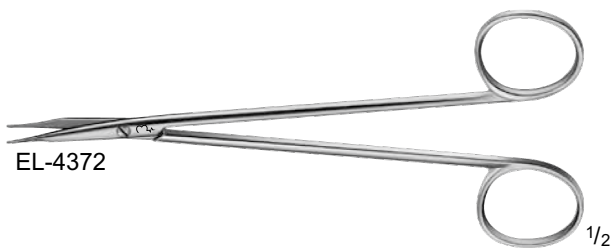

JAMESON Tenotomy Scissors, Delicate

Catalog Number	Tip	Blade	Length (in.)
EL-4372	B/B	CVD	6

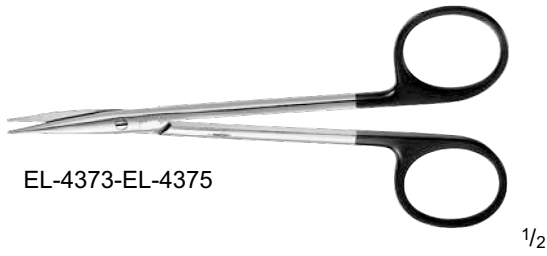

JAMESON SuperCut Scissors, Delicate

Catalog Number	Tip	Blade	Length (in.)
EL-4373	B/B	CVD	5 1/8
EL-4374	B/B	CVD	6
EL-4375	B/B	CVD	7

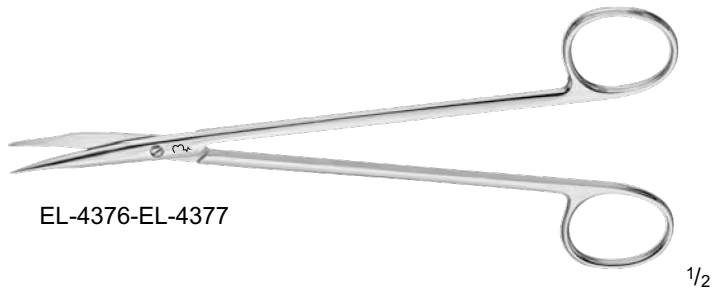

POTTS Tenotomy Scissors

Catalog Number	Tip	Blade	Length (in.)
EL-4376	B/B	CVD	6 7/8
EL-4377	B/B	CVD	8

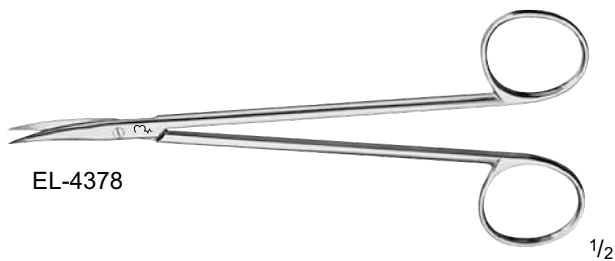

Nerve Dissecting Scissors

Catalog Number	Tip	Blade	Length (in.)
EL-4378	S/S	CVD	6



Plastic Surgery Scissors

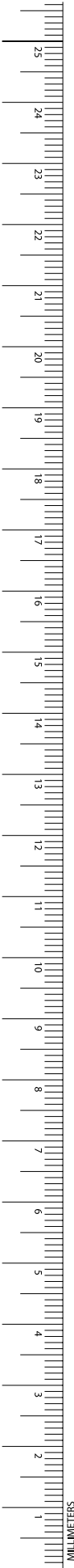

EL-4379-EL-4380

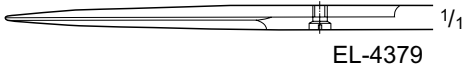

EL-4379



EL-4380

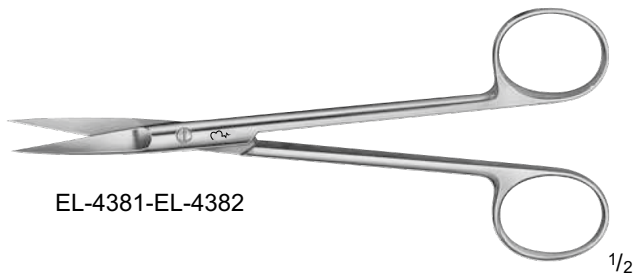

EL-4381-EL-4382

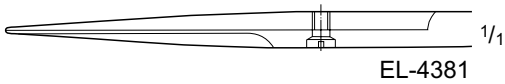

EL-4381

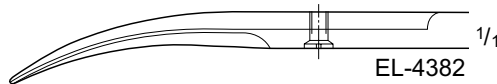

EL-4382



EL-4383

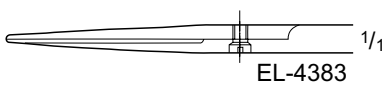

EL-4383

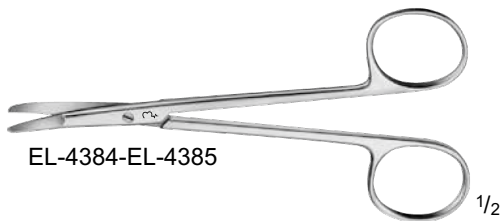

EL-4384-EL-4385

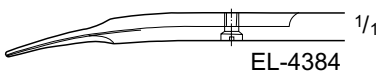

EL-4384

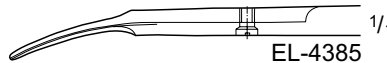

EL-4385

JOSEPH Scissors, Delicate

Catalog Number	Tip	Blade	Handle	Length (in.)
EL-4379	S/S	STR	SQUARE	6
EL-4380	S/S	CVD	SQUARE	6
EL-4381	S/S	STR	ROUND	6
EL-4382	S/S	CVD	ROUND	6

KILN Scissors

Catalog Number	Tip	Blade	Length (in.)
EL-4383	S/S	STR	4 1/2
EL-4384	FLAT	CVD	5
EL-4385	FLAT	CVD	6



EL-4386-EL-4387

1/2

Strabismus Scissors

Catalog Number	Tip	Blade	Length (in.)
EL-4386	B/B	STR	4 1/2
EL-4387	B/B	CVD	4 1/2

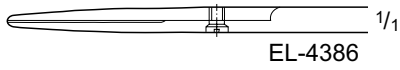

EL-4386

1/1

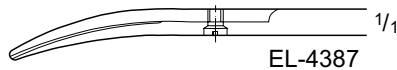

EL-4387

1/1



EL-4388

1/2

LITTLER Scissors

Catalog Number	Tip	Blade	Length (in.)
EL-4388	W/EYE	CVD	4 1/2

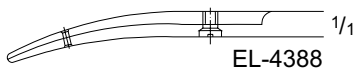

EL-4388

1/1



Plastic Surgery Scissors

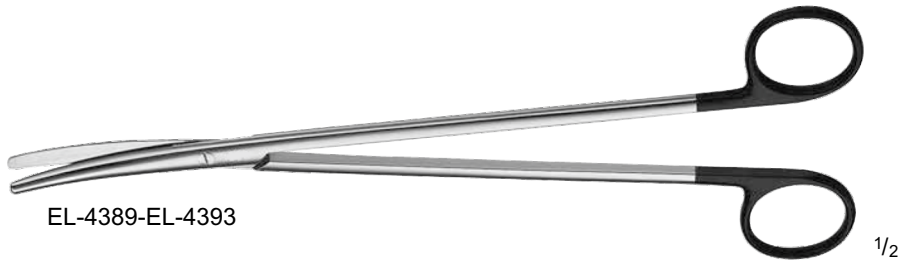
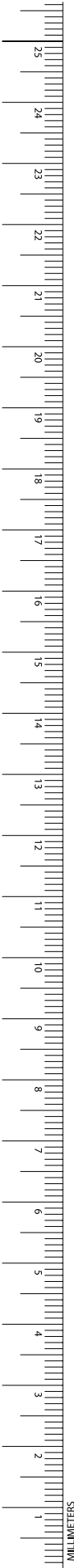

METZENBAUM SuperCut Scissors

Catalog Number	Tip	Blade	Length (in.)
EL-4389	B/B	CVD	9
EL-4390	B/B	CVD	10 1/4
EL-4391	B/B	CVD	11 1/4
EL-4392	B/B	CVD	11 3/4
EL-4393	B/B	CVD	14

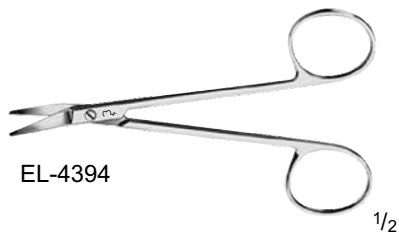
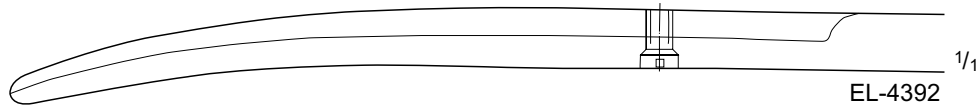
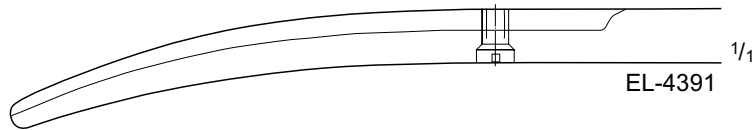
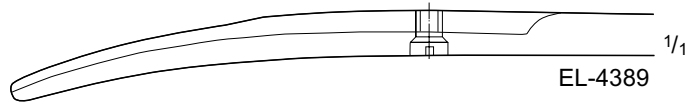

GRAEFE Scissors

Catalog Number	Tip	Blade	Length (in.)
EL-4394	B/B	LAT-ANG	4

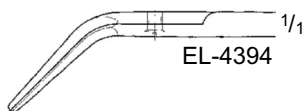

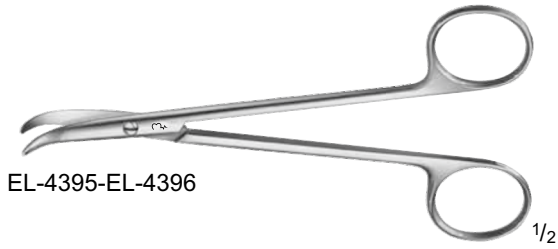

EL-4395-EL-4396

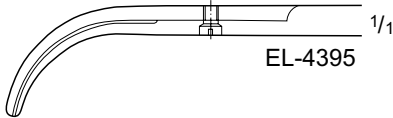

EL-4395

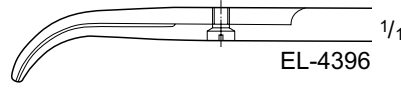

EL-4396

FOMON Lower Lateral Scissors

Catalog Number	Tip	Blade	Length (in.)
EL-4395	B/B	HEAVY-CVD	4 1/2
EL-4396	B/B	HEAVY-CVD	5 1/4



EL-4397-EL-4398

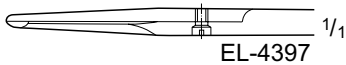

EL-4397

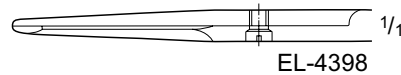

EL-4398

SPENCER Suture Scissors

Catalog Number	Blade	Length (in.)
EL-4397	STR	3 1/2
EL-4398	STR	4 1/2



EL-4399

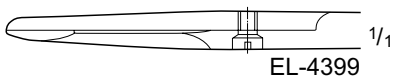

EL-4399

LITTAUER Ligature Scissors

Catalog Number	Blade	Length (in.)
EL-4399	STR	5 1/4



Plastic Surgery Scissors

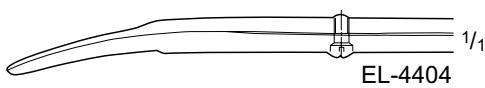
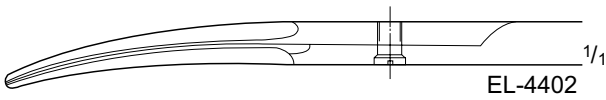
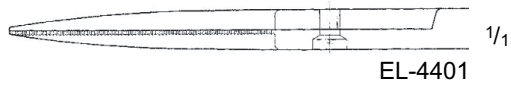
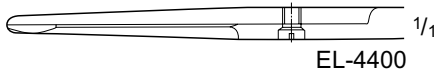
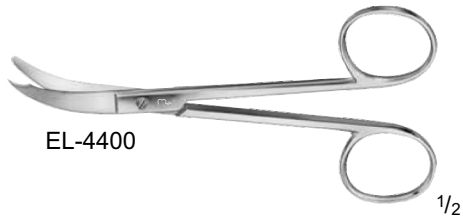
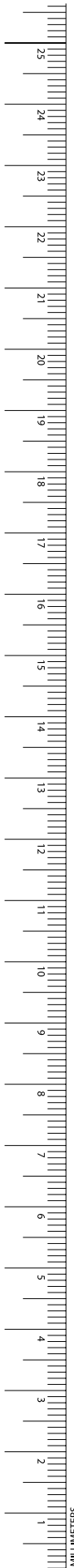

NORTHBENT Ligature Scissors

Catalog Number	Tip	Blade	Length (in.)
EL-4400	B/B	LAT-CVD	4 3/4

Cartilage Scissors

Catalog Number	Tip	Blade	Length (in.)
EL-4401	S/S	SERR	7 1/4

KAYE Facelift Scissors

Catalog Number	Tip	Blade	Length (in.)
EL-4402	SEMI-SHARP	CVD, SERR	6
EL-4403	SEMI-SHARP	CVD, SERR	7 1/2

METZENBAUM-LIPSETT Scissors

Catalog Number	Tip	Blade	Length (in.)
EL-4404	B/B	CVD	5 1/2



EL-4405-EL-4407

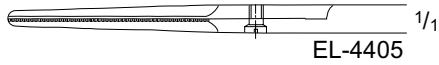

EL-4405

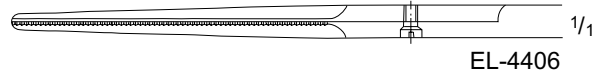

EL-4406

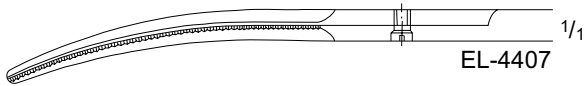

EL-4407

GORNEY Scissors

Catalog Number	Tip	Blade	Length (in.)
EL-4405	B/B	STR	5
EL-4406	B/B	STR	7 3/4
EL-4407	B/B	SLIGHT-CVD	7 3/4



EL-4408

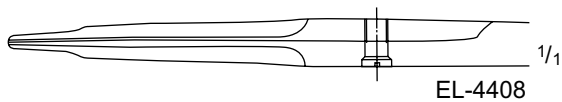

EL-4408



EL-4409

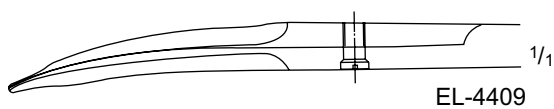

EL-4409

GORNEY-FREEMAN SuperCut Scissors

Catalog Number	Tip	Blade	Length (in.)
EL-4408	BEVELED BLUNT	STR	7 1/4
EL-4409	BEVELED BLUNT	CVD	7 1/4



Plastic Surgery

TC Scissors

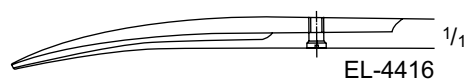
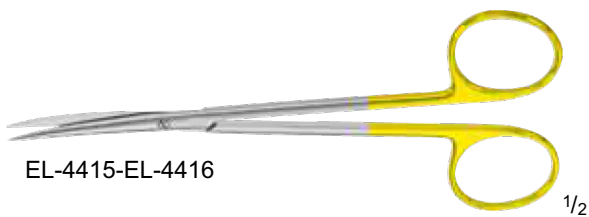
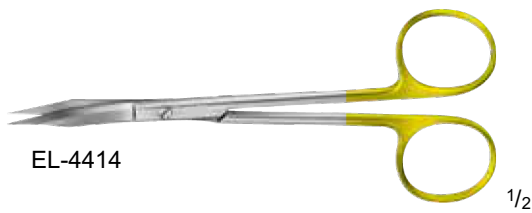
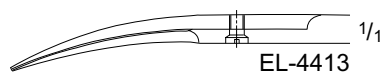
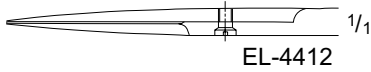
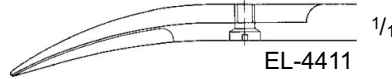
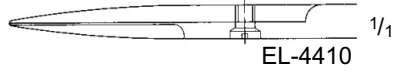
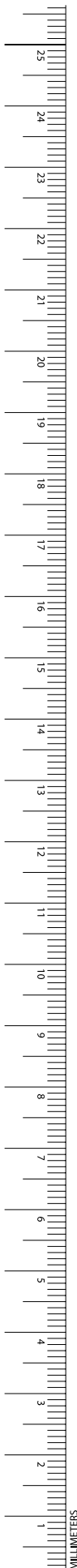

TC Delicate Scissors

Catalog Number	Tip	Blade	Length (in.)
EL-4410	S/S	STR	4 3/4
EL-4411	S/S	CVD	4 3/4

TC Iris Scissors, Delicate

Catalog Number	Tip	Blade	Length (in.)
EL-4412	S/S	STR	4 1/4
EL-4413	S/S	CVD	4 1/4

TC GOLDMAN-FOX Tenotomy Scissors, Delicate

Catalog Number	Tip	Blade	Length (in.)
EL-4414	S/S	CVD, 1/SERR	5 1/8

TC Par Scissors

Catalog Number	Tip	Length (in.)
EL-4415	CVD, BLUNT	4 1/2
EL-4416	CVD, BLUNT	5 3/4

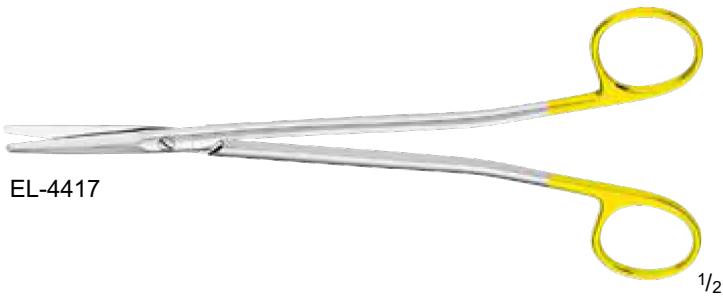

EL-4417

1/2

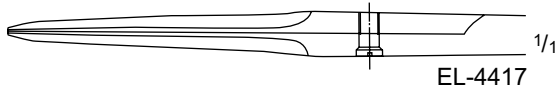

EL-4417

1/1



EL-4418

1/2

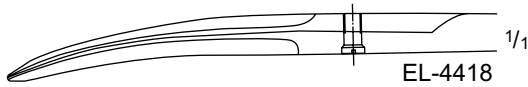

EL-4418

1/1



Wavecut

Wavecut scissors have one serrated cutting edge to help prevent tissue from slipping. The W after the item number indicates the scissors are the wavecut style, e.g.

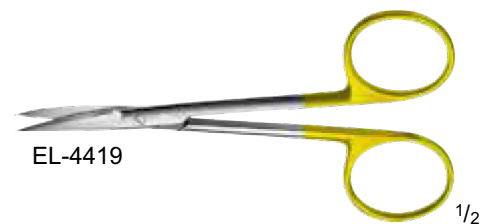

EL-4419

1/2

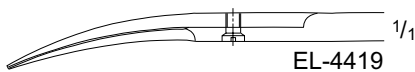

EL-4419

1/1

**TC GORNEY-FREEMAN
Facelift Scissors**

Catalog Number	Blade	Length (in.)
EL-4417	STR, SERR	7 3/4
EL-4418	CVD, SERR	7 3/4

TC Iris Scissors, Wavecut

Catalog Number	Tip	Blade	Length (in.)
EL-4419	S/S	CVD	4 1/4



Plastic Surgery TC Scissors

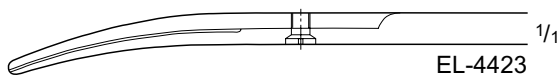
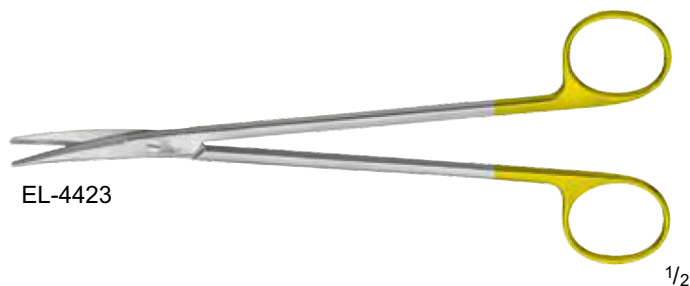
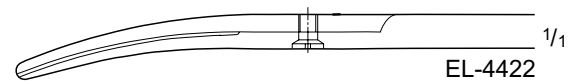
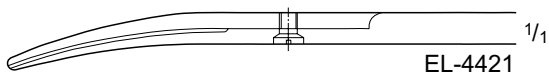
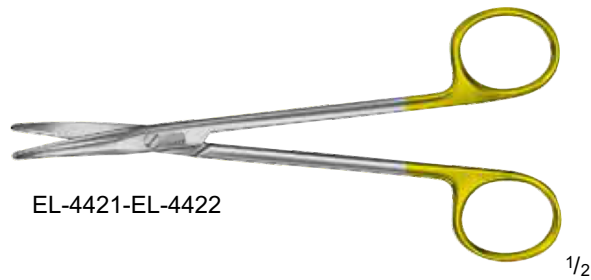
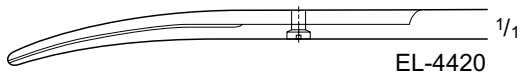
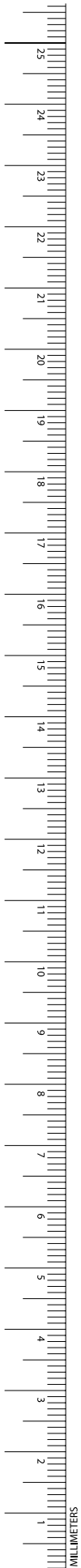

TC Baby METZENBAUM Wavecut Dissecting Scissors, Delicate

Catalog Number	Tip	Blade	Length (in.)
EL-4420	B/B	CVD	5 $\frac{3}{4}$

TC METZENBAUM Wavecut Dissecting Scissors

Catalog Number	Tip	Blade	Length (in.)
EL-4421	B/B	CVD	5 $\frac{3}{4}$
EL-4422	B/B	CVD	7

TC METZENBAUM Wavecut Delicate Scissors

Catalog Number	Tip	Blade	Length (in.)
EL-4423	B/B	CVD	7

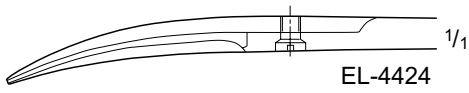

SuperCut Scissors, Delicate

Catalog Number	Tip	Blade	Length (in.)
EL-4424	S/S	CVD	5



GOLDMANN-FOX SuperCut Scissors, Delicate

Catalog Number	Tip	Blade	Length (in.)
EL-4425	S/S	CVD	5 1/8



**Plastic Surgery
SuperCut Scissors**

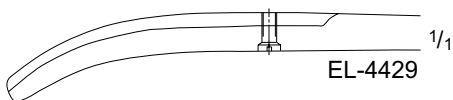
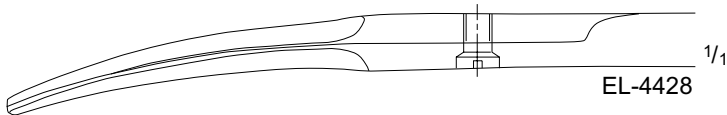
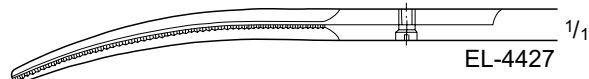
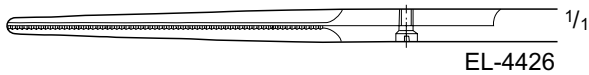
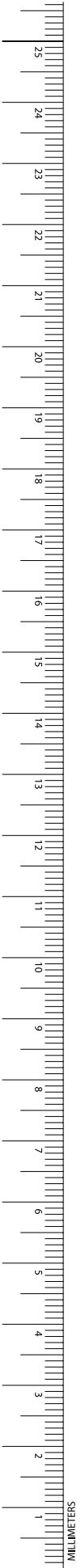

GORNEY SuperCut Scissors, Delicate

Catalog Number	Tip	Blade	Length (in.)
EL-4426	B/B	STR	7 3/4
EL-4427	B/B	CVD	7 3/4

KAYE SuperCut Scissors, Delicate

Catalog Number	Blade	Length (in.)
EL-4428	CVD	7 3/4

FOMON SuperCut Scissors

Catalog Number	Tip	Blade	Length (in.)
EL-4429	B/B	CVD	4 1/2

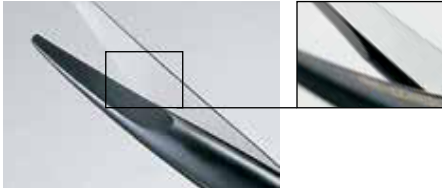

Microtome Edge

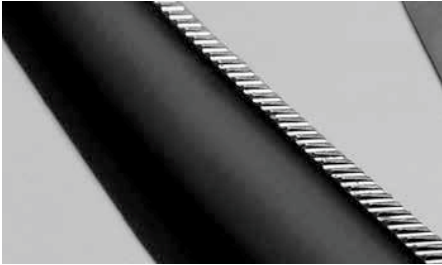

Wavecut

Supreme Cut Scissors

The combination of the renowned Elite Tungsten Carbide technology with the Elite coating results in an extremely high surface hardness and therefore high wear resistance in daily hospital use.

- **Microtome edge**
The extremely sharp cutting edge of the scissors blade facilitates gentle cutting of tissue with minimal use of force.
- **Wavecut helps prevent tissue from slipping out during the cutting process.**
- **The WB after the item number indicates the scissors are the wavecut style, e.g.**



EL-4430-EL-4432



EL-4430



EL-4431-EL-4432

Iris Dissecting Scissors

Catalog Number	Tip	Blade	Length (in.)
EL-4430	S/S	STR	4 1/4
EL-4431	S/S	CVD	4 1/4
EL-4432	S/S	CVD	4 1/4



EL-4433-EL-4434



EL-4433-EL-4434

Strabismus Dissecting Scissors

Catalog Number	Tip	Blade	Length (in.)
EL-4433	B/B	CVD	4 1/2
EL-4434	B/B	CVD	4 1/2

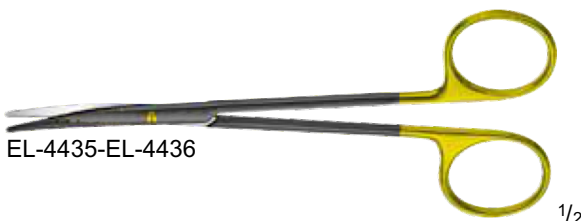

EL-4435-EL-4436



EL-4435-EL-4436

Baby METZENBAUM Dissecting Scissors

Catalog Number	Tip	Blade	Length (in.)
EL-4435	B/B	CVD	5 3/4
EL-4436	B/B	CVD	5 3/4



Plastic Surgery Supreme Cut Scissors

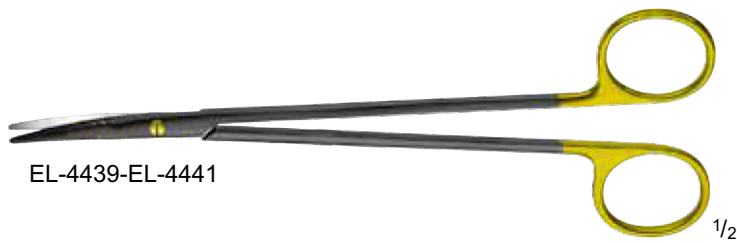
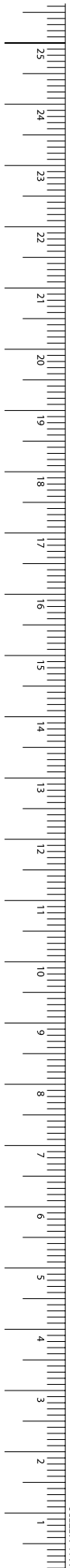

METZENBAUM Dissecting Scissors

Catalog Number	Tip	Blade	Length (in.)
EL-4437	B/B	CVD	5 3/4
EL-4438	B/B	CVD	5 3/4

METZENBAUM Dissecting Scissors

Catalog Number	Tip	Blade	Length (in.)
EL-4439	B/B	CVD	7
EL-4440	B/B	CVD	7
EL-4441	B/B	CVD, DEL	7
EL-4442	B/B	CVD, DEL	7

TOENNIS-ADSON Dissecting Scissors

Catalog Number	Tip	Blade	Length (in.)
EL-4443	B/B	CVD, DEL	6 7/8
EL-4444	B/B	CVD, DEL	6 7/8



EL-4445-EL-4446

1/2



EL-4445

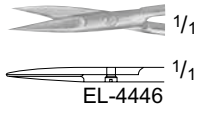

EL-4446



EL-4457-EL-4461

1/2



EL-4447

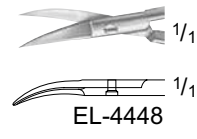

EL-4448

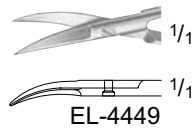

EL-4449

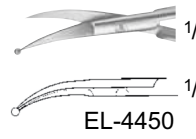

EL-4450

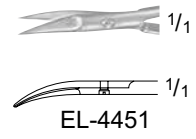

EL-4451



EL-4452-EL-4453

1/2

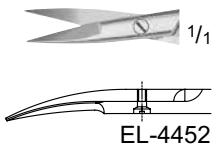

EL-4452

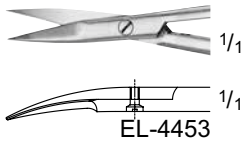

EL-4453

MUELLER Micro Scissors

Catalog Number	Tip	Handle Color	Blade	Length (in.)
EL-4445	S/S	BLUE	STR	4 3/4
EL-4446	S/S	BLUE	STR	6 3/4
EL-4447	S/S	BLUE	CVD	4 3/4
EL-4448	S/B	BLUE	CVD	4 3/4
EL-4449	B/B	BLUE	CVD	4 3/4
EL-4450	S/BALL-PT	BLUE	CVD	4 3/4
EL-4451	S/S	BLUE	CVD	6 3/4

Micro Scissors, Golf Ball Handle

Catalog Number	Blade	Length (in.)
EL-4452	SLIGHT CVD, 1/SERR	7
EL-4453	CVD	7



Plastic Surgery

Micro Scissors and Needle Holders

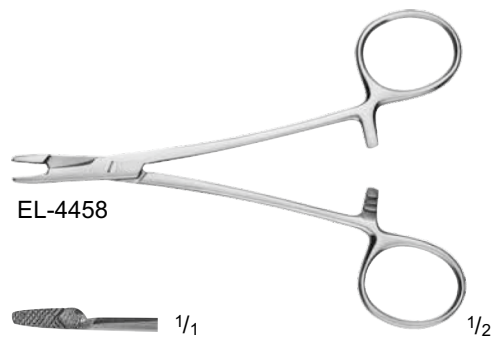
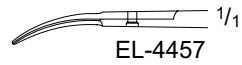
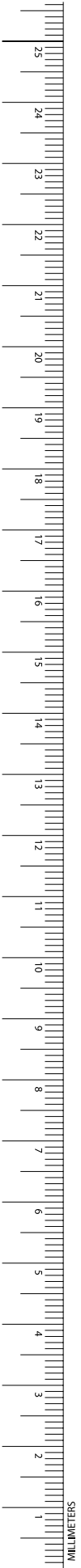

Micro Scissors, Golf Ball Handle

Catalog Number	Blade	Length (in.)
EL-4454	STR	7
EL-4455	CVD	7

YASARGIL Micro Vessel Scissors

Catalog Number	Blade	Handle	Length (in.)
EL-4456	STR	FLAT SERR	7 1/4
EL-4457	CVD	FLAT, SERR	7 1/4

HEGAR-OLSEN Needle Holder

Catalog Number	Tip	Length (in.)
EL-4458	SERR	4 3/4

Elite features Needle Holders with Tungsten Carbide (TC) inserts. A smooth jaw and three different serration patterns are available, depending on the size of the suture needle.



We recommend carbide inserts as follows:

Jaw Surface	Suture Material
Smooth	9/0 - 11/0
0.2 mm pitch of serration	6/0 - 10/0
0.4 mm pitch of serration	4/0 - 6/0
0.5 mm pitch of serration	up to 3/0

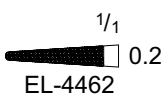
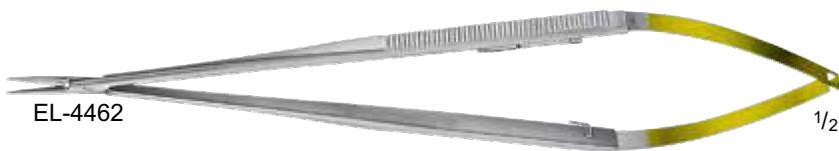
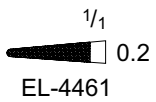
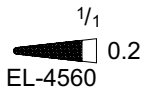
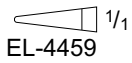

TC CASTROVIEJO Micro Needle Holder, Flat Handle

Catalog Number	Jaw	Length (in.)
EL-4459	SMOOTH	5 3/4
EL-4560	SERR	5 3/4
EL-4461	SERR	7
EL-4462	SERR	8 1/2



Plastic Surgery
TC Needle Holders

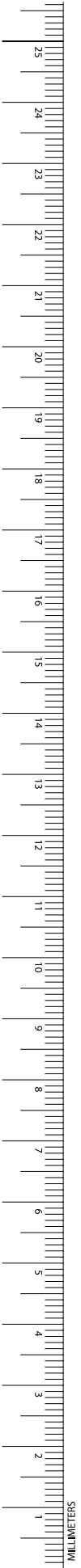

EL-4463

1/2

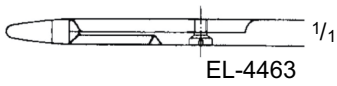

EL-4463

**TC LEWIN Needle Holder/
Scissors**

Catalog Number	Jaw	Length (in.)
EL-4463	SMOOTH	5

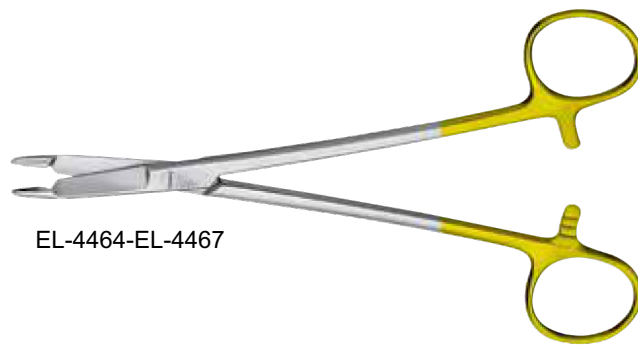

EL-4464-EL-4467

**TC HEGAR-OLSON
Needle Holder/Scissors**

Catalog Number	Jaw	Length (in.)
EL-4464	SMOOTH	4 3/4
EL-4465	SERR	4 3/4
EL-4466	SERR	5 3/4
EL-4467	SERR	6 1/2



EL-4464



EL-4465

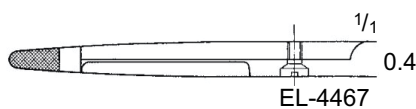

EL-4467



EL-4466



EL-4468

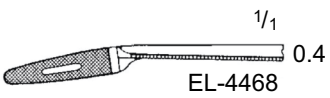

**TC GILLIES Needle Holder/
Scissors**

Catalog Number	Jaw	Handle	Length (in.)
EL-4468	SERR	OFF-SET	6 1/4



EL-4469-EL-4473

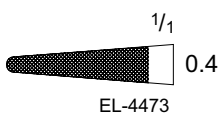
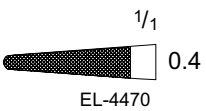
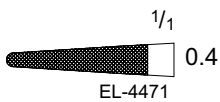
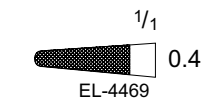

**TC CRILE-WOOD
Needle Holder**

Catalog Number	Jaw	Length (in.)
EL-4469	SERR	5 3/4
EL-4470	SERR	7 1/4
EL-4471	SERR	7 7/8
EL-4472	SERR	10 5/8
EL-4473	SERR	12

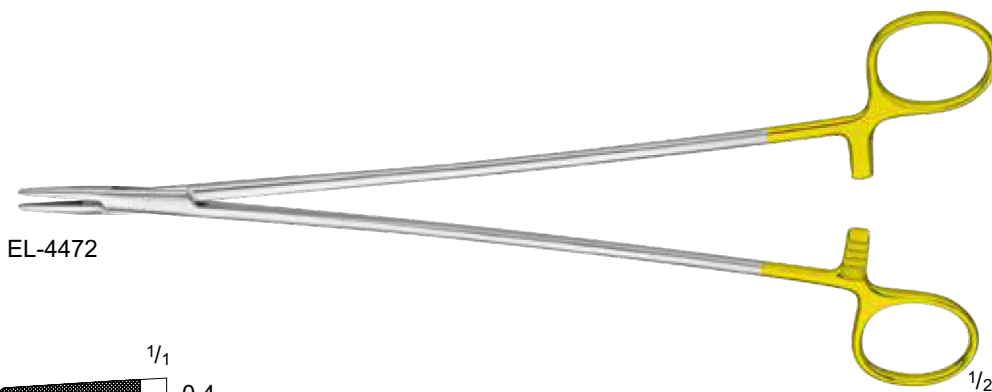

EL-4472

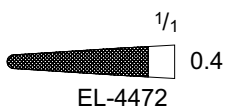

Plastic Surgery
TC Needle Holders

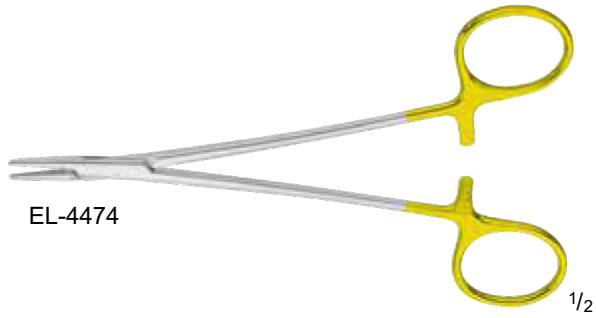
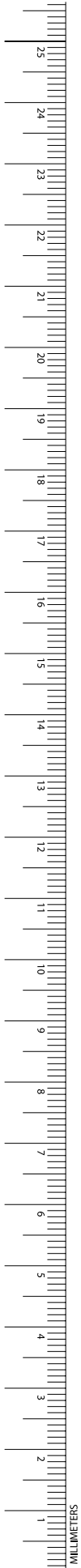

EL-4474

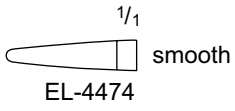

EL-4474

TC CRILE-WOOD
Needle Holder

Catalog Number	Jaw	Length (in.)
EL-4474	SMOOTH	6

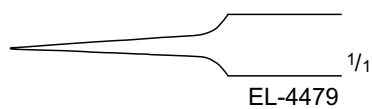
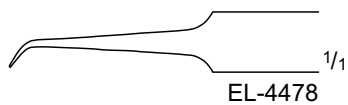
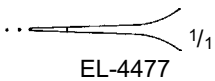

CASTROVIEJO Suture Forceps

Catalog Number	Tip Size (mm)	Teeth	Length (in.)
EL-4475	0.12	1 x 2	4 1/8

CASTROVIEJO COLIBRI Type Corneal Forceps

Catalog Number	Tip Size (mm)	Teeth	Length (in.)
EL-4476	0.12	1 x 2	4 1/8

BONN Eye Forceps, W/ Platform

Catalog Number	Tip Size (mm)	Teeth	Length (in.)
EL-4477	0.2	1 x 2	3 3/4

Jewelers Forceps

Catalog Number	Tip Size (mm)	Tip	Length (in.)
EL-4478	0.3	ANG	4 1/4

Micro Forceps #4 Jewelers

Catalog Number	Tip Size (mm)	Length (in.)
EL-4479	0.2	4 1/4



Plastic Surgery Dressing and Tissue Forceps

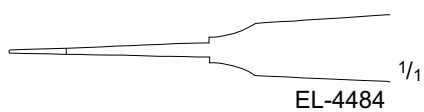
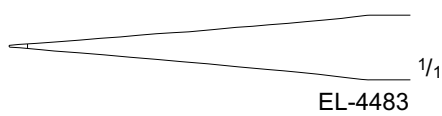
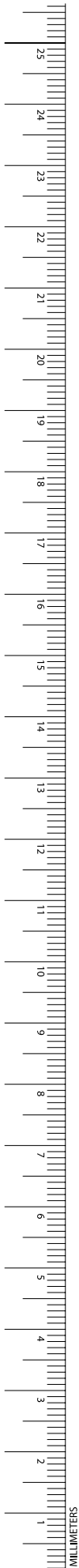

Micro Jewelers Forceps

Catalog Number	Tip Size (mm)	Teeth	Length (in.)
EL-4480	0.4	1 x 2	5 1/4

WISE Micro Suture Forceps

Catalog Number	Tip Size (mm)	Tip	Length (in.)
EL-4481	0.3	STR	5 1/4
EL-4482	0.3	CVD	5 1/4

Micro Suture Forceps, W/ Platform

Catalog Number	Tip Size (mm)	Length (in.)
EL-4483	0.3	4 3/4

AUSTIN Micro Suture Forceps, W/ Platform

Catalog Number	Tip Size (mm)	Length (in.)
EL-4484	0.8	5 1/2



Micro Suture Forceps, Round Handle

Catalog Number	Tip Size (mm)	Tip	Length (in.)
EL-4485	0.3	STR	6
EL-4486	0.5	STR	7
EL-4487	0.3	CVD	6
EL-4488	0.5	CVD	7



EL-4485 1/1



EL-4487

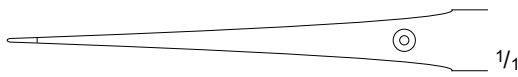

EL-4486 1/1



EL-4488

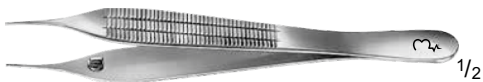

MICRO-ADSON-BIEMER Forceps

Catalog Number	Teeth	Length (in.)
EL-4489	1 x 2	4 3/4

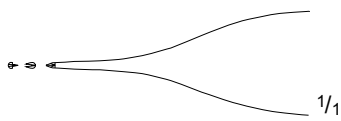

EL-4489



Plastic Surgery

Dressing and Tissue Forceps

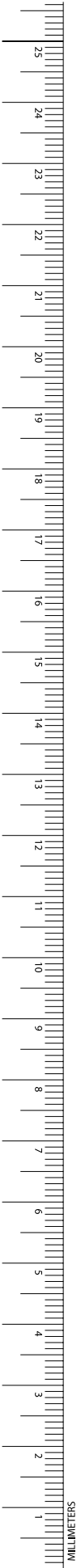

EL-4490-EL-4495

1/2

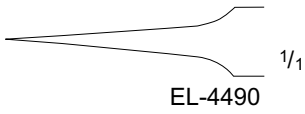

EL-4490

1/1

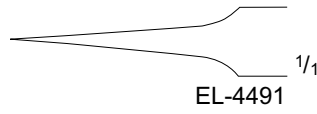

EL-4491

1/1

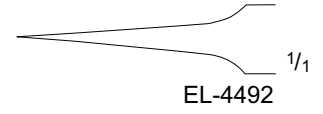

EL-4492

1/1

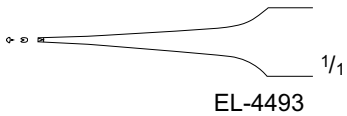

EL-4493

1/1

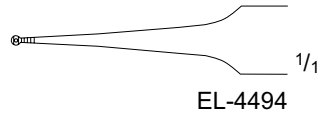

EL-4494

1/1

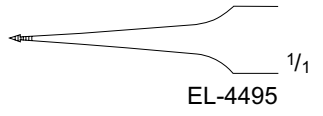

EL-4495

1/1



EL-4496

1/2

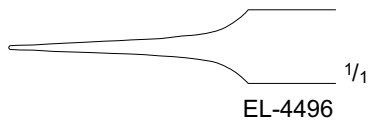

EL-4496

1/1



EL-4497

1/2

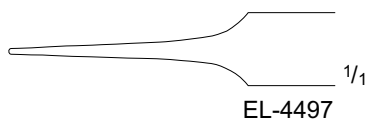

EL-4497

1/1

MUELLER Micro Forceps

Catalog Number	Tip Size (mm)	Handle Color	Teeth	Length (in.)
EL-4490	0.15	BROWN	-	4 1/4
EL-4491	0.20	BROWN	-	4 1/4
EL-4492	0.30	BROWN	-	4 1/4
EL-4493	0.50	BLACK	1 x 2	4 1/4
EL-4494	1.20	GREY	RING	4 1/4
EL-4495	1.20	GREY	TRI	4 1/4

LAZAR Micro Suture Forceps

Catalog Number	Tip Size (mm)	Length (in.)
EL-4496	0.5	6 1/8
EL-4497	0.8	6 1/8

Plastic Surgery Bone and Tendon Forceps

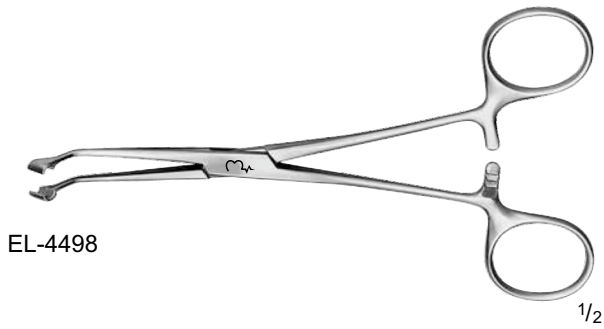

EL-4498

1/2



1/1



EL-4498

1/1

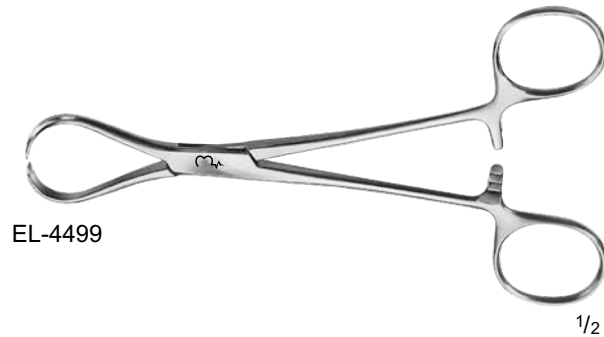

EL-4499

1/2



1/1

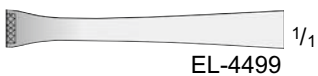

EL-4499

1/1



EL-4500-EL-4501

1/2

HERZ Tendon Seizing Forceps

Catalog Number	Jaw	Length (in.)
EL-4498	CVD	6 1/8

JACKSON Tendon Seizing Forceps

Catalog Number	Teeth	Length (in.)
EL-4499	4 x 5	6 1/8

BUNNELL Tendon Passing Probe

Catalog Number	Length (in.)
EL-4500	7 3/8
EL-4501	9



INCHES

Plastic Surgery

Bone and Tendon Forceps

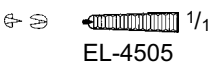
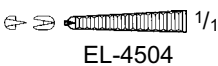
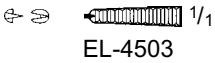
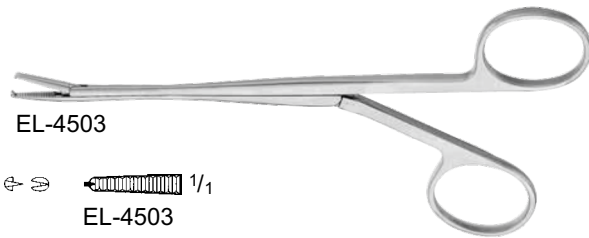
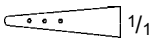
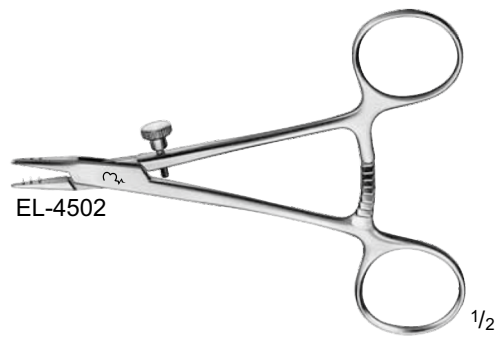
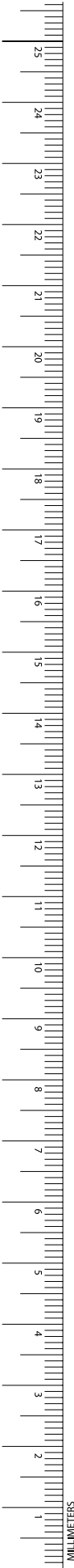

Tendon Seizing Forceps, W/ 3 Pins

Catalog Number	Length (in.)
EL-4502	4 3/4

BRAND Tendon Holding Forceps

Catalog Number	Jaw	Teeth	Length (in.)
EL-4503	STR	1 x 2	6
EL-4504	STR	1 x 2	7 1/4
EL-4505	CVD	1 x 2	6
EL-4506	CVD	1 x 2	7 1/4

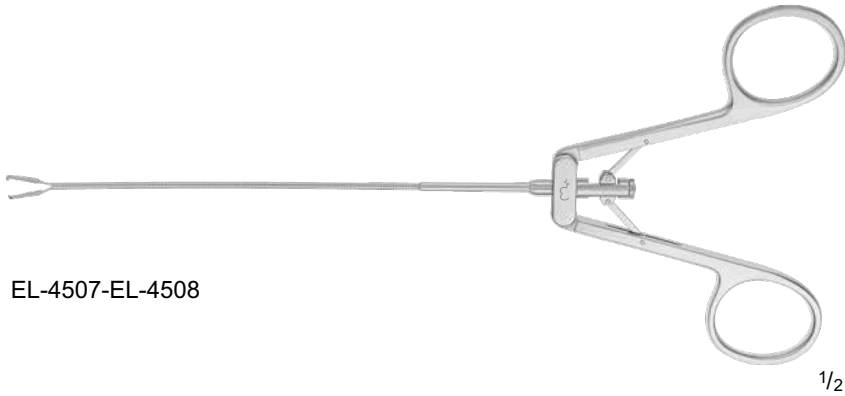

EL-4507-EL-4508

1/2



EL-4507

1/1



EL-4508

1/1



EL-4509

1/2

KLEINERT-KUTZ Tendon Retriever

Catalog Number	Size	Shaft	Length (in.)
EL-4507	-	FLEXIBLE	8
EL-4508	SMALL	RIGID	8 1/4

CARROLL Tendon Pulling Forceps

Catalog Number	Length (in.)
EL-4509	6



Plastic Surgery

Bone and Tendon Forceps

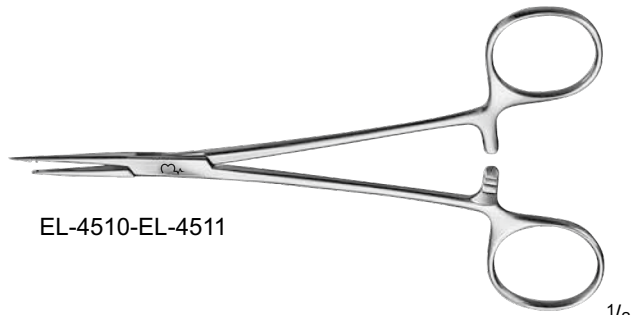
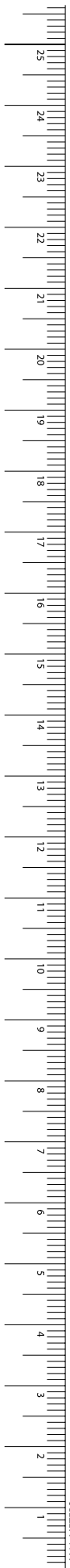

EL-4510-EL-4511

1/2

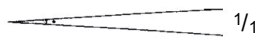

1/1



EL-4510

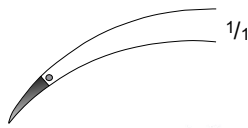

1/1



EL-4511

Tendon Interlacing Forceps

Catalog Number	Jaw	Length (in.)
EL-4510	STR	6
EL-4511	CVD	6

Tendon Stripper

Catalog Number	Length (in.)
EL-4512	11 3/4
EL-4513	19 3/4



EL-4512-EL-4513

1/2



EL-4512

1/1



1/1



EL-4513

1/1



1/1



EL-4514

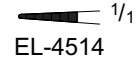

EL-4514



EL-4515-EL-4517



EL-4515

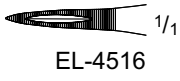

EL-4516



EL-4517

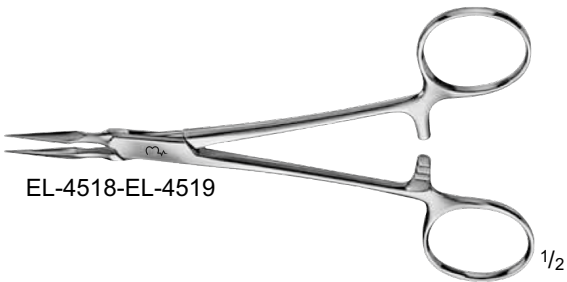

EL-4518-EL-4519



EL-4518

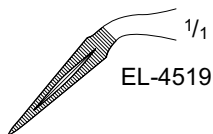

EL-4519



EL-4520



EL-4520

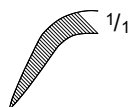

1/1

Splinter Forceps

Catalog Number	Length (in.)
EL-4514	3 1/8

FEILCHENFELD Splinter Forceps

Catalog Number	Length (in.)
EL-4515	3
EL-4516	3 3/4
EL-4517	4 1/2

STIEGLITZ Splinter Forceps

Catalog Number	Jaw	Length (in.)
EL-4518	STR	5 1/2
EL-4519	CVD	5 1/2

PEET Splinter Forceps

Catalog Number	Length (in.)
EL-4520	4 3/4



Plastic Surgery Hemostatic Forceps



CARREL Artery Forceps

Catalog Number	Length (in.)
EL-4521	3 $\frac{1}{4}$

DANDY Forceps

Catalog Number	Jaw	Jaw Shape	Length (in.)
EL-4522	SERR	CVD	5 $\frac{1}{2}$
EL-4523	1 x 2 Teeth	LAT-CVD	5 $\frac{1}{2}$

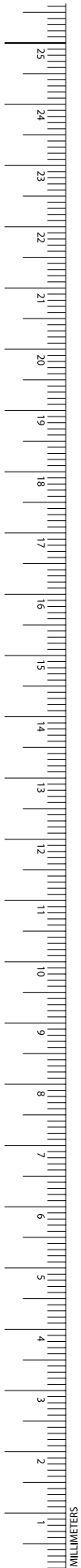

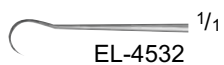
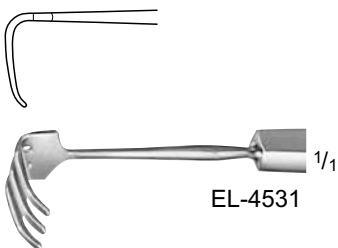
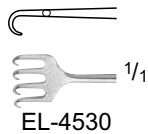
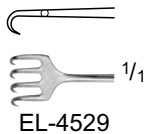
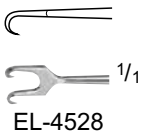
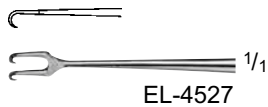
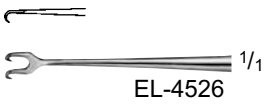
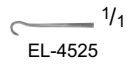
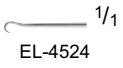

GRAEFE Hook

Catalog Number	Tip	Length (in.)
EL-4524	SHARP	5
EL-4525	BLUNT	5

GUTHRIE Double Hook

Catalog Number	Tip	Length (in.)
EL-4526	SHARP	5
EL-4527	SHARP	5 1/8

ROLLET Hook Retractor

Catalog Number	Tip	Blade End	Length (in.)
EL-4528	SHARP	2 PRONG	5 1/8
EL-4529	SHARP	4 PRONG	5 1/4
EL-4530	BLUNT	4 PRONG	5 1/4

PAUL Tendon Hook

Catalog Number	Tip	Blade End	Tip Size (mm)	Length (in.)
EL-4531	BLUNT	3 PRONGS	11 x 8	4 3/4

JAEGER Hook Retractor, Fine

Catalog Number	Tip	Length (in.)
EL-4532	SHARP	5 1/4



Plastic Surgery Hooks and Retractors

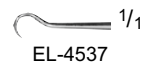

KLEINERT-KUTZ Skin Hook

Catalog Number	Size	Tip	Tip Size (mm)	Length (in.)
EL-4533	1	SHARP	2.5	6 1/4
EL-4534	2	SHARP	4.2	6 1/4
EL-4535	3	SHARP	4.8	6 1/4

KILNER Skin Hook

Catalog Number	Tip	Length (in.)
EL-4536	SHARP	6 1/4

GILLIES Skin Hook

Catalog Number	Hook End	Tip	Length (in.)
EL-4537	SMALL	SHARP	7
EL-4538	LARGE	SHARP	7

COTTLE Hook

Catalog Number	Tip	Length (in.)
EL-4539	CVD, SHARP	6 1/4
EL-4540	ANG, SHARP	6 1/4

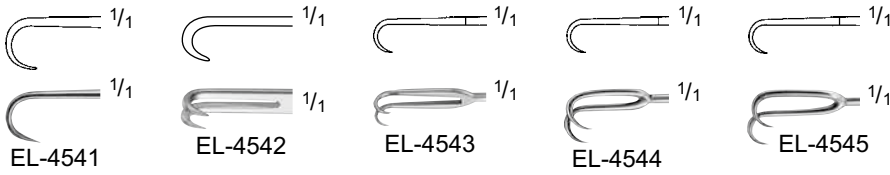

JOSEPH Skin Hook

Catalog Number	Tip	Prongs	Tip Size (mm)	Length (in.)
EL-4541	SHARP	1	-	6 1/2
EL-4542	SHARP	2	2	6 1/4
EL-4543	SHARP	2	3	6 1/2
EL-4544	SHARP	2	6	6 1/2
EL-4545	SHARP	2	8	6 1/2
EL-4546	SHARP	2	10	6 1/2



COTTLE-JOSEPH Double Hook

Catalog Number	Tip Size (mm)	Length (in.)
EL-4547	12	5 3/4



FREER Double Hook

Catalog Number	Length (in.)
EL-4548	6

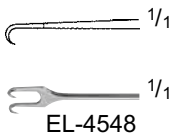

GRAEFE Strabismus Nerve/Vessel Ho

Catalog Number	Tip	Length (in.)
EL-4549	SMALL	5 1/2
EL-4550	MEDIUM	5 1/2
EL-4551	LARGE	5 1/2

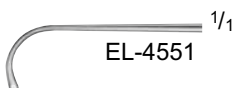
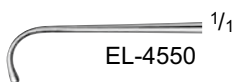
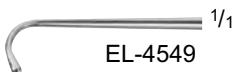

Plastic Surgery Hooks and Retractors

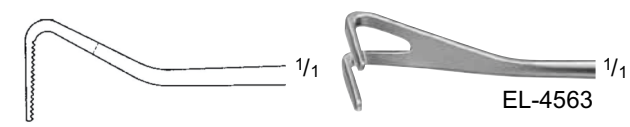
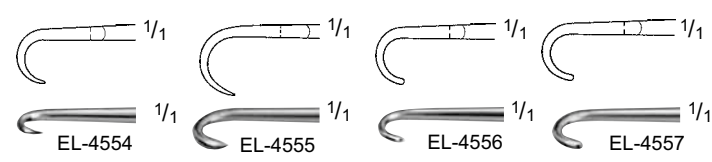
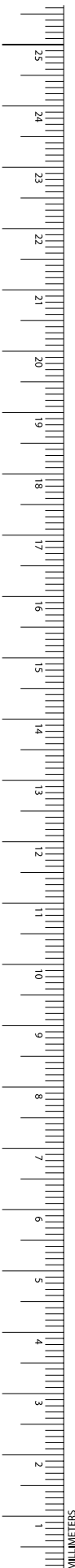

MANNERFELT Retractor

Catalog Number	Prongs	Tip	Blade Shape	Blade Size (mm)	Length (in.)
EL-4552	1	SHARP	HOOK CVD	-	5 1/4
EL-4553	1	SHARP	HOOK CVD	-	6 1/8
EL-4554	1	SHARP	SMALL CVD	SMALL PRONG	6 1/8
EL-4555	1	SHARP	SMALL CVD	LARGE PRONG	6 1/8
EL-4556	1	BLUNT	SMALL CVD	SMALL PRONG	6 1/8
EL-4557	1	BLUNT	SMALL CVD	LAGRGE PRONG	6 1/8
EL-4558	2	SHARP	SMALL CVD	3.5 x 12	6 1/8
EL-4559	2	SHARP	SMALL CVD	5 x 4	6 1/8
EL-4560	2	SHARP	SMALL CVD	8 x 8	6 1/8
EL-4561	2	BLUNT	SMALL CVD	5.5 x 4	6 1/8
EL-4562	2	BLUNT	SMALL CVD	7 x 8	6 1/8
EL-4563	2	SHORT	ANG	8 x 12.5	6 1/8
EL-4564	3	SHARP	SMALL CVD	5.5 x 7.2	6 1/8
EL-4565	3	SHARP	SMALL CVD	7 x 11	6 1/8
EL-4566	3	BLUNT	SMALL CVD	5.5 x 7.2	6 1/8
EL-4567	3	BLUNT	SMALL CVD	7 x 11	6 1/8



LANGENBECK-MANNERFELT Retractor

Catalog Number	Blade Size (mm)	Length (in.)
EL-4568	15 x 6	6 1/8
EL-4569	20 x 6	6 1/8
EL-4570	25 x 6	6 1/8
EL-4571	30 x 8	6 1/8

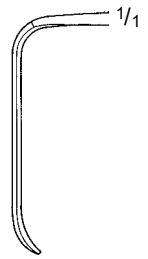
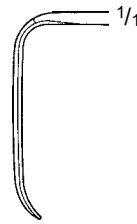
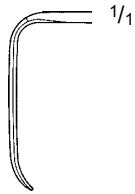
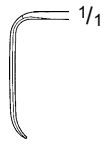

MANNERFELT Saddle Hook

Catalog Number	Tip Size (mm)	Length (in.)
EL-4572	16 x 16	6 1/8
EL-4573	12 x 12	6 1/8
EL-4574	12 x 14	6 1/8
EL-4575	14 x 16	6 1/8
EL-4576	12 x 12 FEN	6 1/8

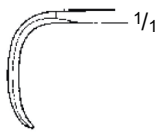

MANNERFELT Tendon Double Hook

Catalog Number	Length (in.)
EL-4577	6 1/4



Plastic Surgery Hooks and Retractors

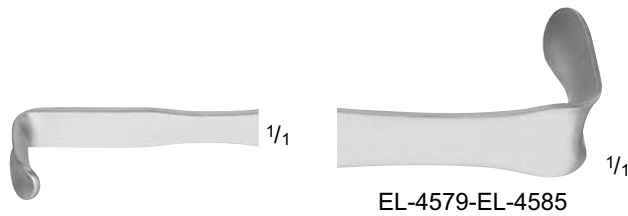

MANNERFELT Double Spatula

Catalog Number	Length (in.)
EL-4578	6 1/4

CRILE Retractor

Catalog Number	Size	Blade Size (mm)	Length (in.)
EL-4579	1	3 x 11 / 6 x 21	4 1/4
EL-4580	2	6 x 13 / 10 x 21	6 1/8
EL-4581	3	16 x 25 / 17 x 35	6 1/4
EL-4582	4	22 x 29 / 29 x 44	7
EL-4583	5	29 x 41 / 35 x 51	7
EL-4584	6	32 x 64 / 35 x 70	7 7/8
EL-4585	7	41 x 76 / 51 x 79	8 7/8

TEBBETTS Breast Spatula, Semi-Malleable

Catalog Number	Length (in.)
EL-4586	12 1/2

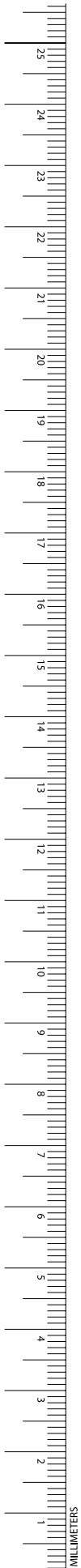

TEBBETTS Breast Retractor

Catalog Number	Blade	Length (in.)
EL-4587	DBL-ENDED	12

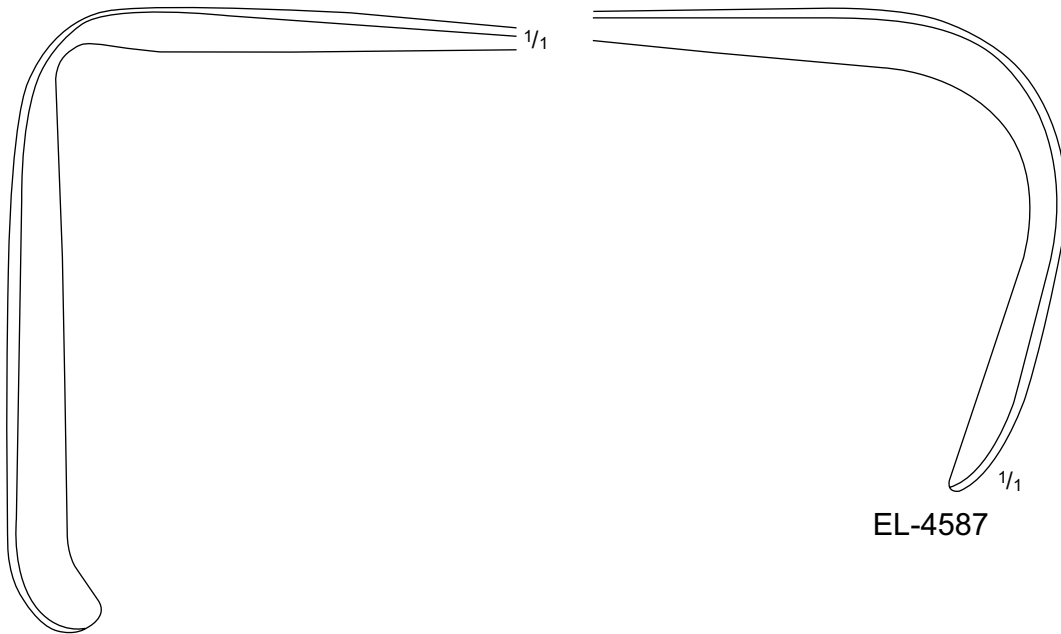

FREEMAN Facelift Retractor

Catalog Number	Length (in.)
EL-4588	7



Plastic Surgery Hooks and Retractors



COTTLE Alar (MASING) Retractor

Catalog Number	Blade Size (mm)	Length (in.)
EL-4589	6 x 12	5 1/2
EL-4590	10 x 12	5 1/2

DESMARRES Lid Retractor

Catalog Number	Blade Size (mm)	Length (in.)
EL-4591	9 x 9	5 1/2
EL-4592	9 x 12	5 1/2
EL-4593	11 x 14	5 1/2
EL-4594	12 x 16	5 1/2
EL-4595	13 x 18	5 1/2



EL-4596

1/2



EL-4596



EL-4597

1/2

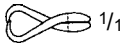

EL-4597



EL-4598

1/2

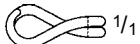

EL-4598



EL-4599

1/2



EL-4599



EL-4600-EL-4601



EL-4600



EL-4601

FINSEN Retractor

Catalog Number	Tip	Blade End	Length (in.)
EL-4596	SHARP	2 x 3 PRONGS	2

FINSEN Retractor

Catalog Number	Tip	Blade End	Length (in.)
EL-4597	SHARP	3 x 4 PRONGS	2 3/4

FINSEN Modified Retractor

Catalog Number	Tip	Blade End	Length (in.)
EL-4598	BLUNT	2 x 3 PRONGS	3

FINSEN Retractor

Catalog Number	Tip	Blade End	Length (in.)
EL-4599	SHARP	3 x 4 PRONGS	2 3/4

HEISS Self-Retaining Retractor

Catalog Number	Tip	Prongs	Length (in.)
EL-4600	SHARP	4 x 4	4
EL-4601	BLUNT	4 x 4	4



Plastic Surgery Hooks and Retractors



EL-4602-EL-4603



EL-4602



EL-4603

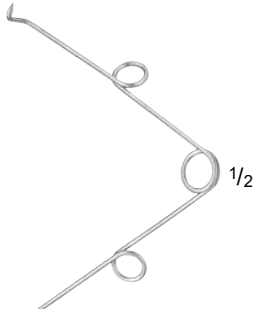

EL-4604

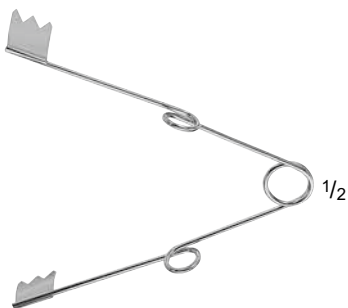

EL-4605-EL-4606

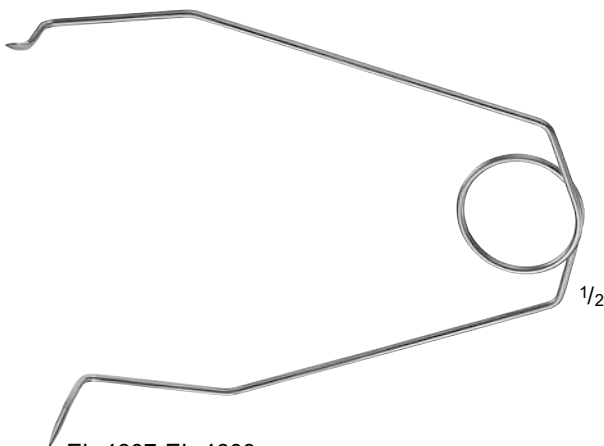

EL-4607-EL-4609

Spring Wire Retractor

Catalog Number	Tip	Prongs	Length (in.)
EL-4602	BLUNT	3 x 3	1 3/4
EL-4603	BLUNT	3 x 3	2 1/4
EL-4604	SHARP	1 x 1	3

Spring Wire Retractor

Catalog Number	Length (in.)
EL-4605	3 1/2
EL-4606	4 1/2

Spring Wire Retractor

Catalog Number	Size	Length (in.)
EL-4607	SMALL	5
EL-4608	MEDIUM	5 1/8
EL-4609	LARGE	9

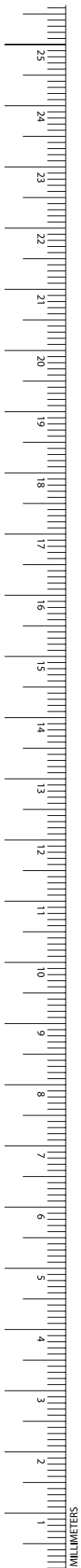

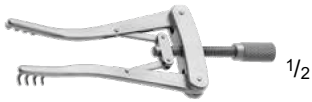

EL-4610-EL-4611

ALM Retractor

Catalog Number	Tip	Prongs	Length (in.)
EL-4610	SHARP	4 x 4	2 3/4
EL-4611	SHARP	4 x 4	4



EL-4610



EL-4611



EL-4612

ALLPORT Retractor

Catalog Number	Tip	Prongs	Length (in.)
EL-4612	SHARP	4 x 4	3 3/4

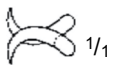

EL-4612

Plastic Surgery
Aluminum Hand

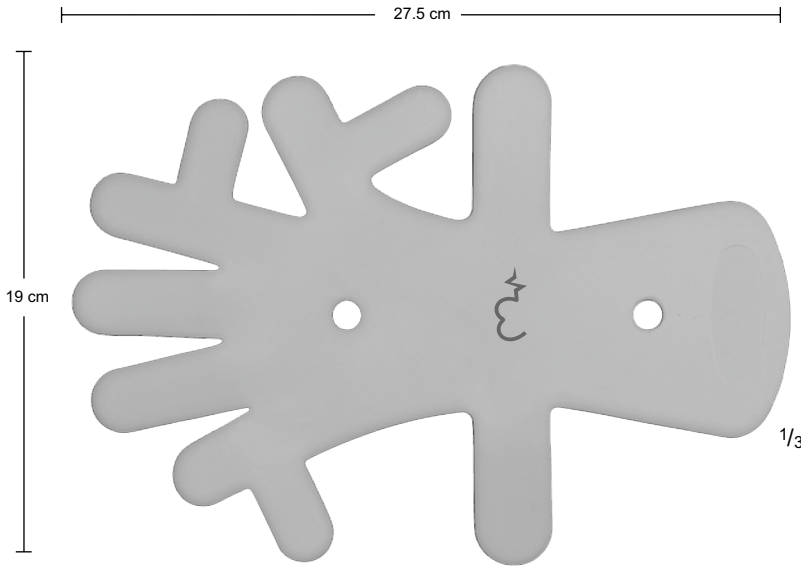
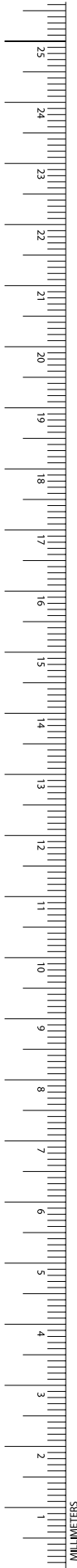

EL-4613

Aluminum Hand, Blue Silicone Coated

Catalog Number	Size (in.)
EL-4613	10 3/4 x 7 1/2
EL-4614	16 1/8 x 11

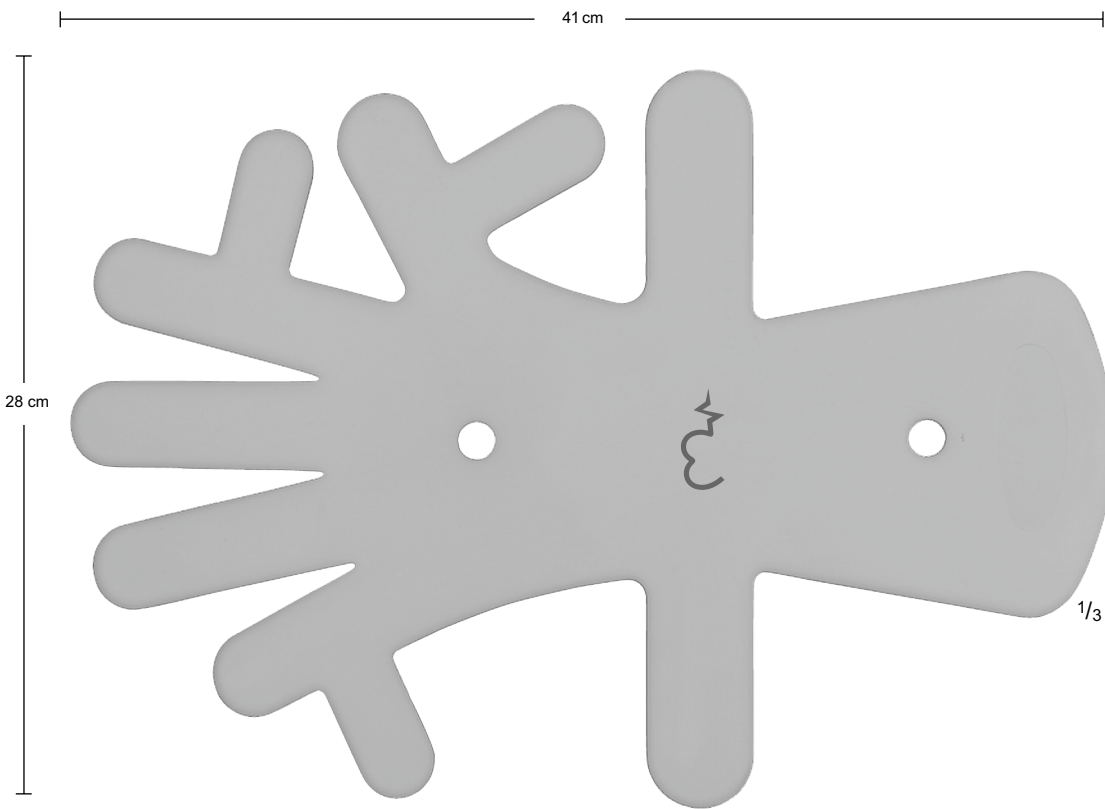

EL-4614

Areola Cookie Cutter

Catalog Number	Diameter (mm)	Blade
EL-4615	33.0	TOOTHED
EL-4616	38.0	TOOTHED
EL-4617	42.0	TOOTHED
EL-4618	48.0	TOOTHED



SCHINK Knife, Adjustable From 0.1 To 2.0MM

Catalog Number	Length (in.)
EL-4619	11 3/4
EL-4620	11 3/4



Plastic Surgery Knives

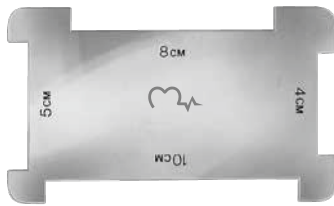

EL-4621



EL-4622



EL-4623



EL-4624



EL-4624

Skin Straightening Plate

Catalog Number
EL-4621

GOULIAN Skin Graft Knife Set

Catalog Number	Length (in.)
EL-4622	7 1/4
EL-4623	BOX/50

TEBBETTS Precision Knife Handle

Catalog Number	Blade Size (mm)	Length (in.)
EL-4624	10 - 15	5 3/4

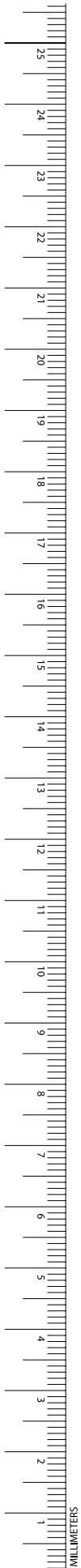

Skin Graft Knife

Catalog Number	Item	Length (in.)
EL-4625	SPARE BLADE, STERILE, 10/PKG	-
EL-4626	KNIFE, W/ O BLADE	11 3/4

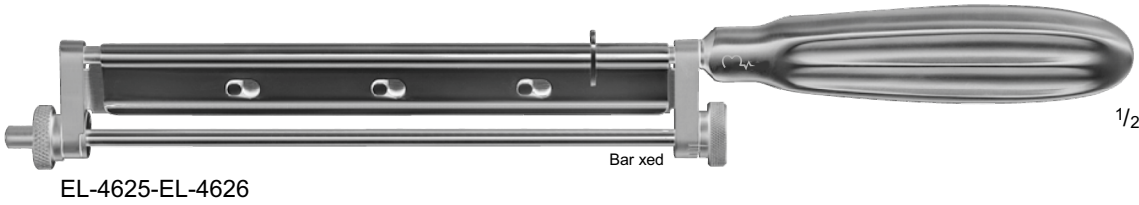

KEYES Dermal Punch Set

Catalog Number
EL-4627

5 interchangeable tips, handle and rack



FOX Dermal Curettes

Catalog Number	Diameter (mm)	Length (in.)
EL-4628	2	5 5/8
EL-4629	3	5 5/8
EL-4630	4	5 5/8
EL-4631	5	5 5/8
EL-4632	6	5 5/8



Plastic Surgery Suction Instruments

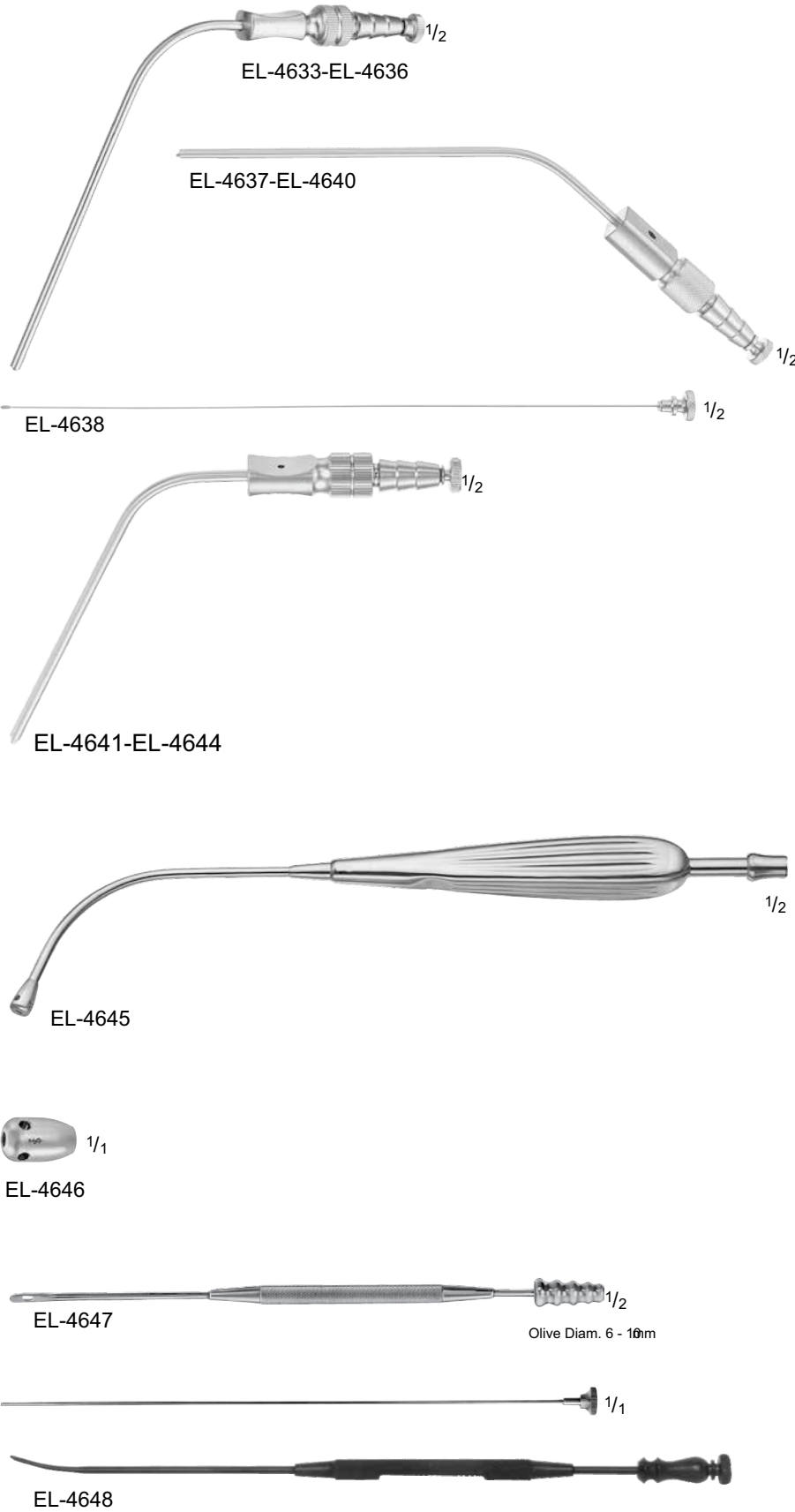
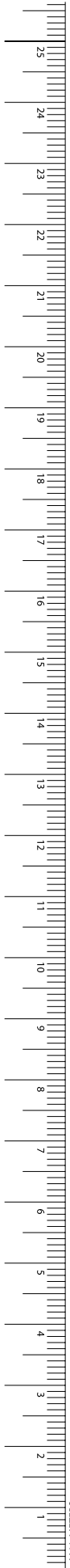

FRAZIER Suction Tube

Catalog Number	Tip Size (FR)	Description	Working Length (in.)
EL-4633	7		4 1/4
EL-4634	7	SUCTION STYLET W/ OLIVE TIP	
EL-4635	7		4 1/4
EL-4636	8	SUCTION STYLET W/ OLIVE TIP	
EL-4637	9		4 1/4
EL-4638		SUCTION STYLET W/ OLIVE TIP	
EL-4639	10		4 1/4
EL-4640	10	SUCTION STYLET W/ OLIVE TIP	
EL-4641	11		4 1/4
EL-4642	11	SUCTION STYLET W/ OLIVE TIP	
EL-4643	12		4 1/4
EL-4644	12	SUCTION STYLET W/ OLIVE TIP	

ANDREWS Pynchon Suction Tube

Catalog Number	Description	Length (in.)
EL-4645	-	9
EL-4646	TIP ONLY	-

GORNEY Suction Dissector, Elevator

Catalog Number	Tip Size (mm)	Length (in.)
EL-4647	6-10	7
EL-4648	3	8 1/2

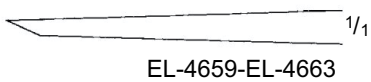
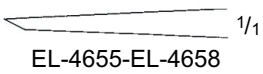
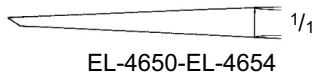

LUCAS Chisel, Angled

Catalog Number	Tip Size (mm)	Length (in.)
EL-4649	4	6 1/4

Chisel, Angled

Catalog Number	Tip Size (mm)	Length (in.)
EL-4650	4	5 1/2
EL-4651	6	5 1/2
EL-4652	8	5 1/2
EL-4653	10	5 1/2
EL-4654	12	5 1/2

PARTSCH Chisel

Catalog Number	Tip Size (mm)	Length (in.)
EL-4655	3	5 1/2
EL-4656	4	5 1/2
EL-4657	5	5 1/2
EL-4658	6	5 1/2
EL-4659	3	6 3/4
EL-4660	4	6 3/4
EL-4661	5	6 3/4
EL-4662	6	6 3/4
EL-4663	7	6 3/4



Plastic Surgery Bone Instruments

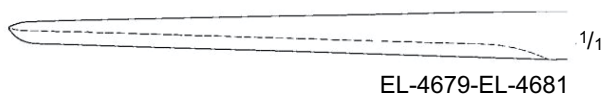
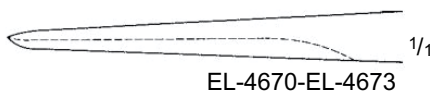
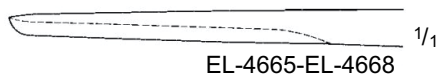
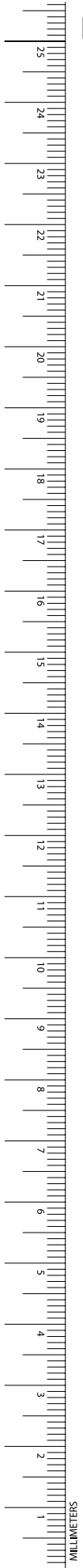

LUCAS Gouge

Catalog Number	Tip Size (mm)	Length (in.)
EL-4664	3	6 1/4

Gouge

Catalog Number	Tip Size (mm)	Length (in.)
EL-4665	4	5 1/2
EL-4666	6	5 1/2
EL-4667	8	5 1/2
EL-4668	10	5 1/2

MANNERFELT Gouge

Catalog Number	Tip Size (mm)	Length (in.)
EL-4669	3	6 1/8

PARTSCH Gouge

Catalog Number	Tip Size (mm)	Length (in.)
EL-4670	3	5 1/2
EL-4671	4	5 1/2
EL-4672	5	5 1/2
EL-4673	6	5 1/2
EL-4674	3	6 3/4
EL-4675	4	6 3/4
EL-4676	5	6 3/4
EL-4677	6	6 3/4
EL-4678	7	6 3/4

ALEXANDER Gouge

Catalog Number	Tip Size (mm)	Length (in.)
EL-4679	7	6 3/4
EL-4680	9	6 3/4
EL-4681	11	6 3/4



EL-4682

1/2

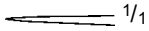

1/1

EL-4682

COTTLE Fishtail Chisel, W/ Protected Ends

Catalog Number	Tip Size (mm)	Length (in.)
EL-4682	8	7



EL-4683-EL-4687

1/2



1/1

EL-4683-EL-4687

STRAND Osteotome

Catalog Number	Tip Size (mm)	Blade	Length (in.)
EL-4683	4	STR	5 1/2
EL-4684	6	STR	5 1/2
EL-4685	8	STR	5 1/2
EL-4686	10	STR	5 1/2
EL-4687	12	STR	5 1/2



EL-4688-EL-4690

1/2

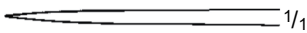

1/1

EL-4688-EL-4690

MANNERFELT Osteotome

Catalog Number	Tip Size (mm)	Length (in.)
EL-4688	4	6 1/8
EL-4689	6	6 1/8
EL-4690	8	6 1/8

∅ 22.5 mm



EL-4691

1/2

Mallet, Lead Filled, 80gr

Catalog Number	Diameter (mm)	Length (in.)
EL-4691	22	6 1/2



Plastic Surgery Bone Instruments



EL-4692-EL-4693

1/2



EL-4693



EL-4694

1/2



EL-4694

1/1

Finger Ring Saw

Catalog Number	Item	Length (in.)
EL-4692	COMPLETE	6
EL-4693	REPLACEMENT BLADE	-

Nail Extracting Forceps

Catalog Number	Length (in.)
EL-4694	5 1/4



OBWEGESER Awl F/ Lower Jaw

Catalog Number	Length (in.)
EL-4695	5 1/2



OBWEGESER Suture Wire Awl

Catalog Number	Length (in.)
EL-4696	7 3/4
EL-4697	9



Plastic Surgery Bone Instruments

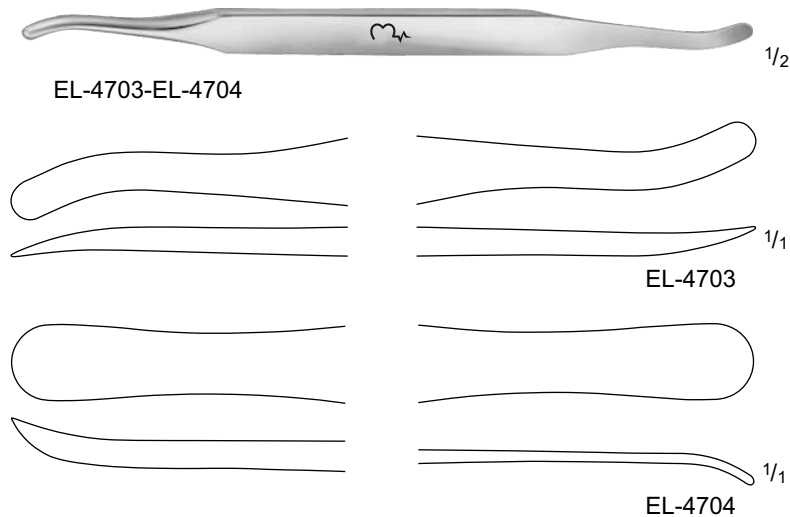
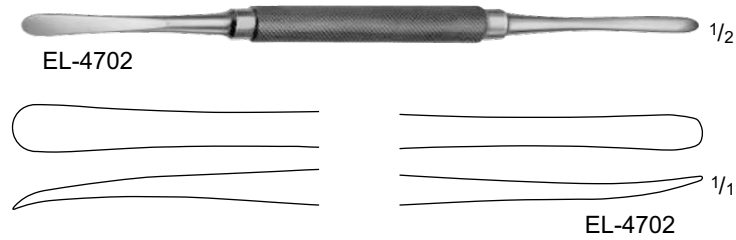
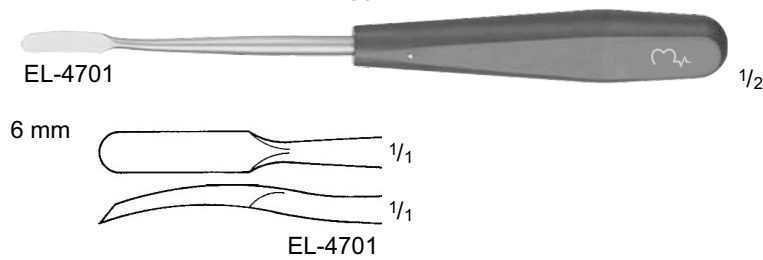
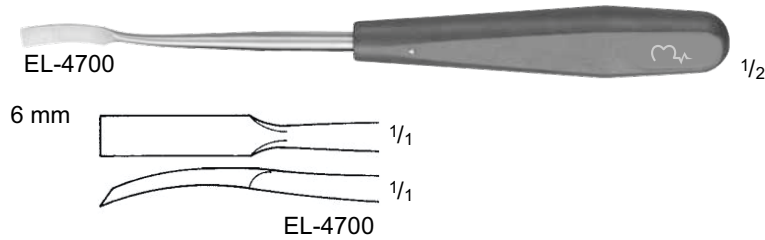
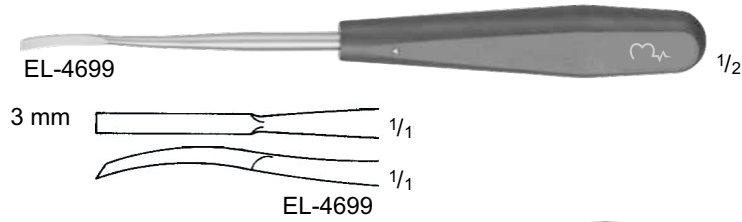
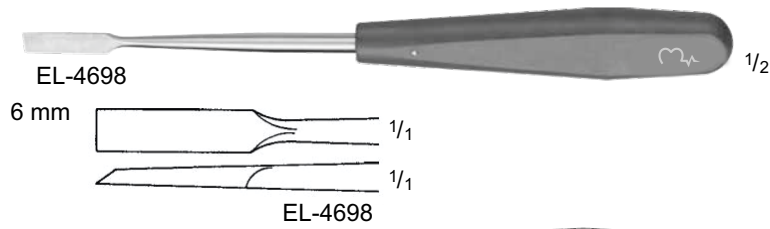
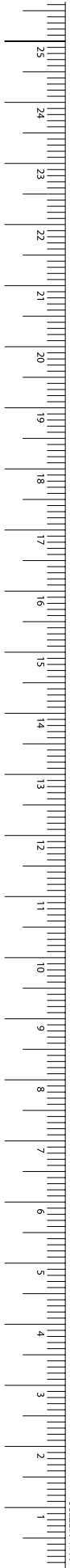

Raspatory W/ PEEK Handle

Catalog Number	Tip	Tip Size (mm)	Blade	Length (in.)
EL-4698	FLAT	6	STR	7 1/2
EL-4699	FLAT	3	CVD	7 1/4
EL-4700	FLAT	6	CVD	7 1/2
EL-4701	RND	6	CVD	7 1/2

MOLT Raspatory and Elevator, Double Ended

Catalog Number	Length (in.)
EL-4702	7

SELDIN Raspatory, Double Ended

Catalog Number	Size	Length (in.)
EL-4703	SMALL	7 3/4
EL-4704	LARGE	7 3/4

Plastic Surgery Bone Instruments

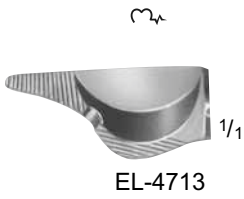
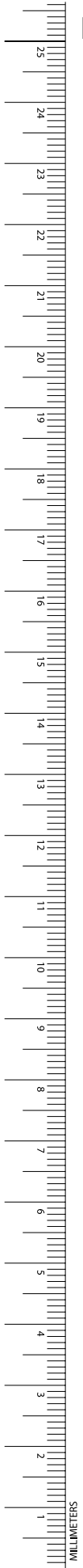

Universal Wire Cutter

Catalog Number	For Wire Size	Length (in.)
EL-4713	SOFT, UP TO 1.5MM AND HARD, UP TO 1.0MM	6
EL-4714	SOFT, UP TO 1.5MM AND HARD, UP TO 1.2MM	6 1/4

Wire Cutter, W/ Specially Hardened Cutting Edges

Catalog Number	For Wire Size	Blade End	Length (in.)
EL-4715	SOFT, UP TO 1.5MM AND	X-HARD EDGE	5 3/4
EL-4716	SOFT, UP TO 1.5MM AND	X-HARD EDGE	5 1/2

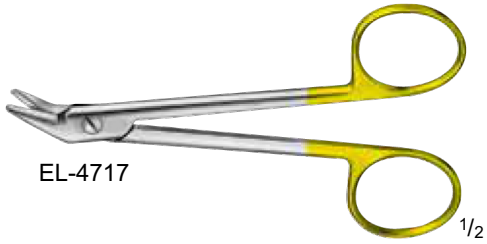

EL-4717

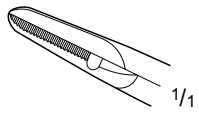

EL-4717

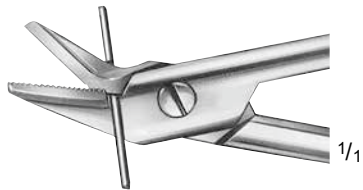

1/16



EL-4718-EL-4721

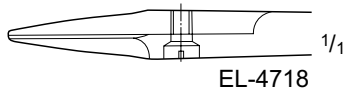

EL-4718

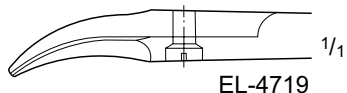

EL-4719

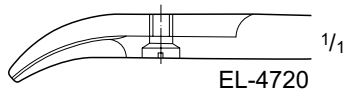

EL-4720

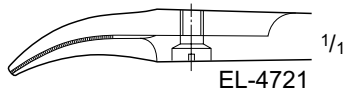

EL-4721

TC Wire Cutting Scissors

Catalog Number	For Wire Size	Blade	Length (in.)
EL-4717	SOFT, UP TO 1.2MM AND HARD, UP TO 0.8 MM	1-SERR	4 3/4

BEEBE Crown Scissors

Catalog Number	Tip	Blade	Length (in.)
EL-4718	SHARP	STR	4 1/4
EL-4719	SHARP	CVD	4 1/4
EL-4720	BROAD	CVD	4 1/4
EL-4721	ONE-SERR	CVD	4 1/4



Plastic Surgery

Micro Vessel Clips and Clamps

- The arterial clips have a slightly inwards curved jaw tip to prevent slipping, see Fig. 1
- The venous clips have a flat parallel closing jaw, see Fig. 2

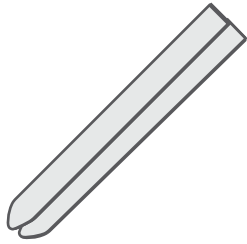

Fig. 1

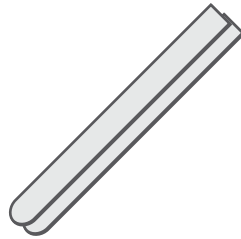
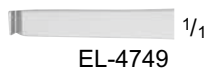
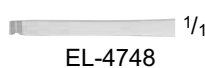
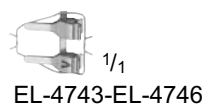
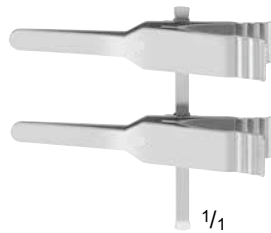
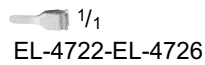

Fig. 2



ACLAND Micro Vessel Clips

Catalog Number	Jaw Length (mm)	Size	Description	Vessel Size (mm)
EL-4722	8	B-1	Artery	0.3-1.0
EL-4723	8	B-1	Vein	0.3-1.0
EL-4724	11	B-2	Artery	0.6-1.4
EL-4725	11	B-2	Vein	0.6-1.4
EL-4726	16	B-3	Artery	1.0-2.2
EL-4727	16	B-3	Vein	1.0-2.2
EL-4728	24	HD-S	Artery	1.5-3.3
EL-4729	24	HD-S	Vein	1.5-3.3
EL-4730	35	RD-S	Artery	2.0-5.0
EL-4731	35	RD-S	Vein	2.0-5.0
EL-4732	8	B-1	Artery	0.3-1.0
EL-4733	8	B-1	Vein	0.3-1.0
EL-4734	11	B-2	Artery	0.6-1.4
EL-4735	11	B-2	Vein	0.6-1.4
EL-4736	16	B-3	Artery	1.0-2.2
EL-4737	16	B-3	Vein	1.0-2.2
EL-4738	24	HD-D	Artery	1.5-3.3
EL-4739	24	HD-D	Vein	1.5-3.3
EL-4740	35	RD-D	Artery	2.0-5.0
EL-4741	35	RD-D	Vein	2.0-5.0
EL-4742	8	B-1	Artery	0.3-1.0
EL-4743	8	B-1	Vein	0.3-1.0
EL-4744	11	B-2	Artery	0.6-1.4
EL-4745	11	B-2	Vein	0.6-1.4
EL-4746	16	B-3	Artery	1.0-2.2
EL-4747	16	B-3	Vein	1.0-2.2
EL-4748	5 1/2	B-1, B-2	Clip Applying Forceps	-
EL-4749	5 1/2	B-3, HD, RD	Clip Applying Forceps	-

All items are sold individually



EL-4750-EL-4752

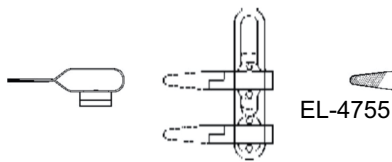
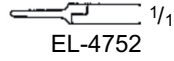
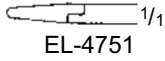
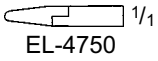

BIEMER Vessel Clip

Catalog Number	Jaw Length (mm)	Jaw Opening (mm)	Closing Force
EL-4750	6	4	30 - 40
EL-4751	9	5	30 - 40
EL-4752	9	5	20 - 25

BIEMER Applying Forceps, F/ FD560R-FD562R, FD611R-FD615R

Catalog Number	Description	Length (in.)
EL-4753	W/ O LOCK	5 1/2
EL-4754	W/ LOCK	5 1/2

BIEMER Micro Approximator Only

Catalog Number	Jaw Length (mm)	Jaw Opening (mm)	Closing Force (gr)
EL-4755	6	2	30 - 40

BIEMER Applying Forceps, F/ FD571R

Catalog Number	Length (in.)
EL-4756	5 3/4



Plastic Surgery

Micro Vessel Clips and Clamps

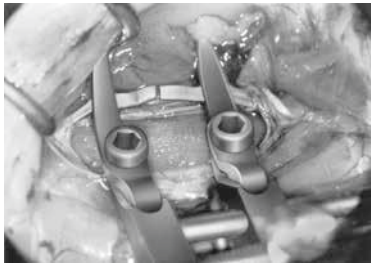

Micro Approximator

Catalog Number	Description
EL-4757	COMPLETE WITH KEY
EL-4758	KEY ALONE

BIEMEL-MÜLLER Approximator

Catalog Number	Blade	Jaw Length (mm)	Jaw Opening (mm)	Closing Force (gr)
EL-4759	STR, DEL	9	4	25 - 30
EL-4760	STR	4,5	3	25 - 30
EL-4761	STR	9	3	25 - 30
EL-4762	ANG, DEL	9	3	25 - 30
EL-4763	ANG	9	3	25 - 30

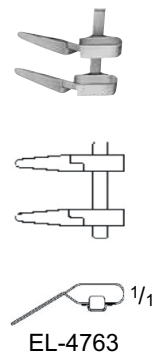
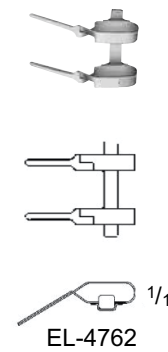
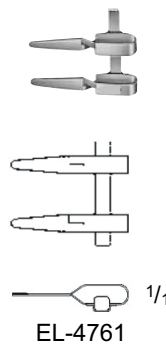
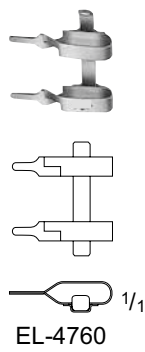
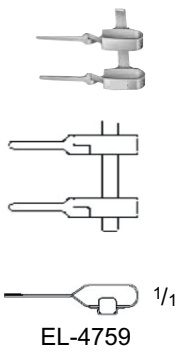

BIEMER Approximator, F/ Nerves

Catalog Number	Description
EL-4764	KEY ALONE
EL-4765	APPROXIMATOR COMPLETE WITH KEY AND NEEDLES
EL-4766	SPARE NEEDLES, PR

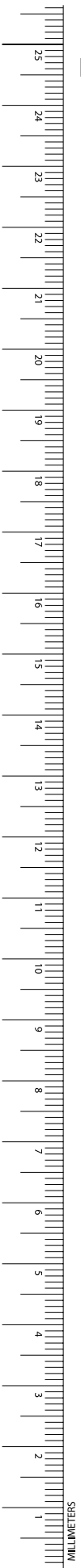



Plastic Surgery Sets

Metzenbaum Scissors, Gator-Grip



Straight

	5½" (14cm)	7" (18cm)	9" (23cm)
Gator-Grip	50-1720	50-1760	50-1795
GG Serrated	50-1680		

Delicate Straight

	5½" (14cm)	7" (18cm)	9" (23cm)
Gator-Grip	50-1721	50-1761	50-1796

Curved

	5½" (14cm)	7" (18cm)	9" (23cm)
Gator-Grip	50-1710	50-1750*	50-1790
GG Serrated	50-1679	50-1677	50-1699

Delicate Curved

	5½" (14cm)	7" (18cm)	9" (23cm)
Gator-Grip	50-1711	50-1751	50-1791
GG Serrated	50-1678	50-1651	50-1681

Metzenbaum Scissors, Super-Cut / Shark-Edge



Straight

	5½" (14cm)	7" (18cm)	9" (23cm)
Super-Cut	56-9050	56-9051	56-9053
Shark-Edge	55-9050	55-9051	55-9053

Delicate Straight

	5½" (14cm)	7" (18cm)	9" (23cm)
Shark-Edge	55-9068	55-9069	

Curved

	5½" (14cm)	7" (18cm)	9" (23cm)
Super-Cut	56-9060	56-9061*	56-9073
Shark-Edge	55-9060	55-9061	55-9063

Delicate Curved

	5½" (14cm)	7" (18cm)	9" (23cm)
Super-Cut	56-9071	56-9072	56-9074
Shark-Edge	55-9071	55-9072	55-9074

Mayo Scissors, Gator-Grip



Straight, Round Blades

	6" (15cm)	6¾" (17cm)	9" (23cm)
Gator-Grip	50-1810	50-1830*	
GG Serrated	50-1815	50-1683	

Curved, Round Blades

	6" (15cm)	6¾" (17cm)	9" (23cm)
Gator-Grip	50-1800	50-1820	
GG Serrated	50-1805	50-1682	

Straight, Beveled Blades

	6" (15cm)	6¾" (17cm)	9" (23cm)
Gator-Grip	51-1830		50-1870

Curved, Beveled Blades

	6" (15cm)	6¾" (17cm)	9" (23cm)
Gator-Grip	51-1820		50-1860

Mayo Scissors, Super-Cut / Shark-Edge



Straight, Round Blades

	5½" (14cm)	6" (15cm)	6¾" (17cm)	9" (23cm)
Super-Cut		56-9041	56-9042	
Shark-Edge		55-9041	55-9042	

Curved, Round Blades

	5½" (14cm)	6" (15cm)	6¾" (17cm)	9" (23cm)
Super-Cut		56-9043	56-9044	
Shark-Edge		55-9043	55-9044	

Straight, Beveled Blades

	5½" (14cm)	6" (15cm)	6¾" (17cm)	9" (23cm)
Super-Cut	56-9020		56-9021	56-9023
Shark-Edge	55-9020		55-9021	55-9023

Curved, Beveled Blades

	5½" (14cm)	6" (15cm)	6¾" (17cm)	9" (23cm)
Super-Cut			56-9031	56-9033
Shark-Edge			55-9031	55-9033

Iris Scissors, Gator-Grip
4 1/2" (11.5cm)



Straight

Gator-Grip	50-3006
------------	---------

GG Serrated	50-3012
-------------	---------

Curved

Gator-Grip	50-3005*
------------	----------

GG Serrated	50-3010
-------------	---------

Iris Scissors, Super-Cut / Shark-Edge
4 1/2" (11.5cm)



Straight

Super-Cut	56-9001*
-----------	----------

Shark-Edge	55-9001
------------	---------

Curved

Super-Cut	56-9003
-----------	---------

Shark-Edge	55-9003
------------	---------

Tenotomy Scissors, Super-Cut / Shark-Edge



Straight

	4 1/2" (11.5cm)	5 1/2" (14cm)	7" (18cm)
--	-----------------	---------------	-----------

Super-Cut	56-9015	56-9017	56-9080
-----------	---------	---------	---------

Shark-Edge	55-9015	55-9017	
------------	---------	---------	--

Curved

	4 1/2" (11.5cm)	5 1/2" (14cm)	7" (18cm)
--	-----------------	---------------	-----------

Super-Cut	56-9016*	56-9018	56-9082
-----------	----------	---------	---------

Shark-Edge	55-9016	55-9018	
------------	---------	---------	--

**Kaye Facelift Scissors
Gator-Grip**

50-3018*
curved, serrated
4½" (11.5cm)

50-3019
curved, serrated
5½" (14cm)

50-3020
curved, serrated
7" (18cm)

50-3022
curved, serrated
9" (23cm)



**Kaye Facelift Scissors
Gator-Grip**

50-1955*
heavy shanks & blades
curved, serrated
5½" (14cm)



**Kaye Facelift Scissors
Super-Cut**

56-9212
beveled blades
curved, serrated
5¾" (14.5cm)

56-9213*
beveled blades
curved, serrated
7½" (19cm)



**Kaye Facelift Scissors, Flared shanks
Super-Cut**

56-9220
beveled blades
straight
7" (18cm)

56-9221*
beveled blades
curved
7" (18cm)



**Gorney-Freeman Facelift Scissors
Gator-Grip**

50-1930
straight, serrated
7½" (19cm)

50-1932*
curved, serrated
7½" (19cm)

50-1936
straight, serrated
9" (23cm)

50-1938
curved, serrated
9" (23cm)



**Gorney Facelift Scissors
Gator-Grip**

50-1884*
straight, serrated
7½" (19cm)

50-1885
curved, serrated
7½" (19cm)



**Gorney-Freeman Facelift Scissors
Super-Cut**

56-9205
beveled blades
straight, serrated
7¼" (18.5cm)

56-9207
beveled blades
curved, serrated
7¼" (18.5cm)

56-9215*
beveled blades
straight, serrated
7½" (19cm)

56-9217
beveled blades
curved, serrated
7½" (19cm)

56-9230
straight, serrated
9" (23cm)

56-9232
curved, serrated
9" (23cm)



**Aston Facelift Scissors
Gator-Grip**

50-1942
double beveled
curved, serrated
6¾" (17cm)

50-1944*
double beveled
curved, serrated
8" (20cm)



**Jabaley Scissors
Shark-Edge**

55-9114
beveled blades
straight
5" (13cm)

55-9116*
beveled blades
curved
5" (13cm)



**Jabaley Scissors
Super-Cut**

56-9114
2 razor edges
straight
5" (12.5cm)

56-9116*
2 razor edges
curved
5" (12.5cm)



**Par Scissors
Gator-Grip**

50-3045*
curved
4½" (11.5cm)

50-3044
curved
5¾" (14.5cm)

50-3046
curved, serrated
4½" (11.5cm)

50-3047
curved, serrated
5¾" (14.5cm)



**Kelly Scissors
Shark-Edge**

55-9130
straight
6¼" (16cm)

55-9131*
curved
6¼" (16cm)



**Joseph Scissors
Shark-Edge**

55-9125*
straight
6" (15cm)

55-9126
curved
6" (15cm)



**Peck-Joseph Scissors
Gator-Grip**

50-3059
double beveled blades
straight, serrated
5¾" (14.5cm)

50-3061*
double beveled blades
curved, serrated
5¾" (14.5cm)



**Rees Facelift Scissors
Gator-Grip**

50-1948
curved, serrated
6¾" (17cm)

50-1950*
curved, serrated
8" (20cm)



Kilner Undermining Scissors

96-5120*
curved
5" (13cm)

96-5121
curved
6" (15cm)

96-5123
curved
8" (20cm)

96-5124
curved
9" (23cm)



**Cottle Dorsal Scissors
Gator-Grip**

50-1895*
heavy serrated blades
6¼" (16cm)



**Foman Dorsal Scissors
Gator-Grip**

50-1890*
angled shanks
straight, serrated
6¼" (16cm)



**Knight Nasal Scissors
Gator-Grip**

50-3095*
angled, serrated
7" (18cm)



**Tebbetts Septal Scissors
Gator-Grip**

50-3090*
angled, serrated
7½" (19cm)



Halstead Mosquito Forceps

14-1201
straight serrated jaw
5" (12.5cm)

14-1202*
curved serrated jaw
5" (12.5cm)

14-1210
straight serrated jaw
1x2 teeth
5" (12.5cm)

14-1211
curved serrated jaw
1x2 teeth
5" (12.5cm)

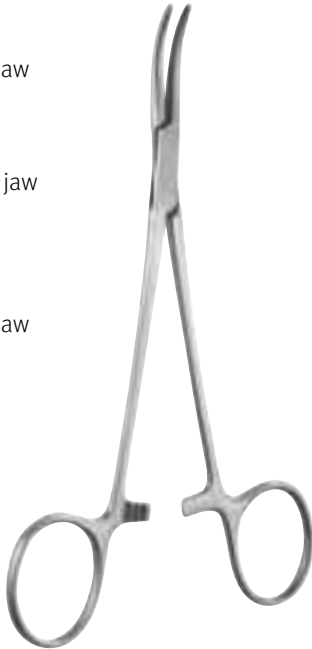

Kelly Forceps

14-1240
straight
5½" (14cm)

14-1241*
curved
5½" (14cm)

14-1280
straight
6¼" (16cm)

14-1281
curved
6¼" (16cm)



Crile Forceps

14-1250
straight
5½" (14cm)

14-1251*
curved
5½" (14cm)

14-1255
straight
6¼" (16cm)

14-1256
curved
6¼" (16cm)



Adson Forceps

14-1416
straight
7¼" (18.5cm)

14-1417*
curved
7¼" (18.5cm)



Lahey Grasping Forceps

95-3060*
straight
3x3 teeth
6" (15cm)

95-3065
straight
3x3 teeth
8" (20cm)



D'Assumpcao Facelift Marker Forceps

96-4180*
6 1/4"

96-4182
with ratchet
6 1/4"



Lockwood Abdominal Demarcator

96-4198*
angled
12 3/4"



**Cushing Forceps
Gator-Grip**

50-1525*
bayonet style
7" (18cm)



**Ferris-Smith Tissue Forceps
Gator-Grip**

50-1512*
1x2 teeth
6¾" (17cm)



**Cushing Forceps
Gator-Grip
Gutsch Handle**

50-1523
straight
delicate tips
7" (18cm)

50-1520*
straight
7" (18cm)

50-1521
angled
7" (18cm)



**Tissue Forceps, 1x2 teeth
Gator-Grip**

50-1322
5½" (14.5cm)

50-1323*
6¼" (16cm)

50-1324
7" (18cm)



**Adson Forceps
Gator-Grip**

50-1500*
serrated jaw
4¾" (12cm)

50-1501
serrated jaw
6" (15cm)



**Adson Tissue Forceps
Gator-Grip**

50-1503*
serrated
1x2 teeth
4¾" (12cm)

50-1508
serrated
1x2 teeth
6" (15cm)



**Adson-Brown Forceps
Gator-Grip**

50-1506*
4x4 teeth
4¾" (12cm)

50-1507
4x4 teeth
6" (15cm)



**Halsey Needle Holders
Gator-Grip**

50-1410*
5" (13cm)

50-1415
smooth jaw
5" (13cm)



**Webster Needle Holders
Gator-Grip**

50-1405*
4½" (11.5cm)



**DeBakey Needle Holders
Gator-Grip, 2mm jaw**

50-2500*
7" (18cm)

50-2503
9" (23cm)

50-2504
10" (25.4cm)

50-2506
12" (30.5cm)



**Derf Needle Holder
Gator-Grip**

50-1400*
4¾" (12cm)



**Olsen-Hegar Needle
Holder/Scissors
Gator-Grip**

50-1158*
delicate jaw
4¾" (12cm)

50-1157
delicate jaw
smooth
4¾" (12cm)



**Olsen-Hegar Needle
Holder/Scissors
Gator-Grip**

50-1160*
5½" (14cm)

50-1170
6¾" (17cm)

50-1180
7½" (19cm)



**Mayo-Hegar Needle Holders
Gator-Grip**

- | | |
|--------------|--------------|
| 50-2436* | 50-2445 |
| 6" (15cm) | 12" (30.5cm) |
| 50-2437 | 50-2442 |
| 7" (18cm) | 14" (35.5cm) |
| 50-2438 | 50-2441 |
| 8" (20cm) | 16" (40.6cm) |
| 50-2439 | 50-2443 |
| 9" (23cm) | 18" (47cm) |
| 50-2440 | |
| 10" (25.4cm) | |



**Crile-Wood Needle Holders
Gator-Grip**

- | | |
|------------|--------------|
| 50-2406* | 50-2409 |
| 6" (15cm) | 9" (23cm) |
| 50-2405 | 50-2429 |
| smooth jaw | curved jaw |
| 6" (15cm) | 9" (23cm) |
| 50-2407 | 50-2410 |
| 7" (18cm) | 10" (25.5cm) |
| 50-2427 | 50-2412 |
| curved jaw | 12" (30.5cm) |
| 7" (18cm) | |
| 50-2408 | |
| 8" (20cm) | |



**Ryder Needle Holders
Gator-Grip, 1mm jaw**

- | | |
|------------|-----------|
| 50-2470* | 50-2477 |
| 6" (15cm) | smooth |
| | 7" (18cm) |
| 50-2471 | 50-2478 |
| 7" (18cm) | smooth |
| 50-2472 | 8" (20cm) |
| 8" (20cm) | |
| 50-2473 | 50-2479 |
| 9" (23cm) | smooth |
| | 9" (23cm) |
| 50-2474 | |
| 10" (25cm) | |
| 50-2476 | |
| smooth | |
| 6" (15cm) | |



**Heaney Needle Holders
Gator-Grip**

- | | |
|---------------|--|
| 50-2525* | |
| 8" (20cm) | |
| 50-2527 | |
| 10½" (26.5cm) | |
| 50-2528 | |
| 12" (30.5cm) | |
| 50-2529 | |
| 14" (35.6cm) | |



**Par Needle Holders
Gator-Grip**

50-1404*
4½" (11.5cm)

50-1403
5" (13cm)

50-1407
smooth jaw
4½" (11.5cm)

50-1408
smooth jaw
5" (13cm)



**Intracardiac Needle Holders
Gator-Grip**

50-2480*
2mm jaw
7" (18cm)

50-2481
2mm jaw
8" (20cm)

50-2482
2mm jaw
9" (23cm)

50-2483
2mm jaw
10" (25.5cm)



**French Eye Needle Holders
Gator-Grip**

50-2490*
3mm jaw
6" (15cm)

50-2491
3mm jaw
7" (18cm)

50-2492
3mm jaw
8" (20cm)

50-2493
3mm jaw
9" (23cm)



**Microvascular Needle Holders
Gator-Grip**

50-2460*
6" (15cm)

50-2461
7" (18cm)

50-2462
8" (20cm)

50-2463
9" (23cm)



**Micro Needle Holders
Delicate Tapered Jaw**

65-3030*
smooth, straight
with lock
7" (18cm)

65-3031
smooth curved
with lock
7" (18cm)

65-3032
smooth, straight
without lock
7" (18cm)

65-3033
smooth, curved
without lock
7" (18cm)



**Castroviejo Needle Holders
Gator-Grip**

50-1440
straight with lock
5½" (14cm)

50-1445*
smooth jaw
straight with lock
5½" (14cm)

50-1441
curved with lock
5½" (14cm)

50-1446
smooth jaw
curved with lock
5½" (14cm)



**Castroviejo Needle Holders
Gator-Grip**

50-1444
straight with lock
7" (18cm)

50-1448*
smooth jaw
straight with lock
7" (18cm)

50-1443
curved with lock
7" (18cm)



Guthrie Skin Hooks

18-5035*
small
1.5mm
4¾" (12cm)

18-5036
large
2mm
4¾" (12cm)



Kleinert-Kutz Skin Hooks

18-5066*
small
6¼" (16cm)

18-5067
medium
6¼" (16cm)

18-5069
large
6¼" (16cm)



Joseph Double Skin Hooks

18-5056
2mm
sharp
6¼" (16cm)

18-5061*
5mm
sharp
6¼" (16cm)

18-5063
7mm
sharp
6¼" (16cm)

18-5064
10mm
sharp
6¼" (16cm)



Joseph Skin Hook

18-5050*
4mm single hook
6¼" (16cm)



Cottle Joseph Double Prong Hooks

93-0315*
12mm
5½" (14cm)

93-0317
12mm
with ball ends
6¼" (16cm)



Self-Retaining Skin Hooks

18-5152*
double hook
2mm
6" (15cm)

18-5155
double hook
5mm
6" (15cm)

18-5158
double hook
8mm
6" (15cm)

18-5161
double hook
11mm
6" (15cm)



Self-Retaining Skin Hook

18-5165*
double hook
with ball tips
13mm
6" (15cm)



Senn Retractors

18-5090*
double ended
3 sharp prongs
6¼" (16cm)

18-5091
double ended
3 blunt prongs
6¼" (16cm)



**MacCollum Dingman
Submammary Dissector**

96-6042*
11¾" (30cm)



Jacobs Transaxillary Dissector

96-6043*
curved shaft
chisel edge
13mm width
17" (43cm)



**Agris Dingman Submammary
Dissector**

96-6060*
transaxial
approach



Breast Dissector & Spatula

93-1397*
semi-malleable blade with
atraumatic teeth on underside
1 x 6" blade (2.5 x 15.2cm)
12½" (31.5cm)



Ribbon Retractors

18-0950
 5/8" (16mm) width
 6 3/4" (17cm) length

18-0959
 5/8" (16mm) width
 8" (20cm) length

18-0953
 1" (25.4mm) width
 7 1/2" (19cm) length

18-0960
 3/4" (19mm) width
 8" (20cm) length

18-0955
 1/4" (6mm) width
 8" (20cm) length

18-0961*
 1" (25.4mm) width
 8" (20cm) length

18-0956
 3/8" (10mm) width
 8" (20cm) length

18-0957
 1/2" (12.7mm) width
 8" (20cm) length



Kasden Thin Bladed Retractor

93-1360*
 double-ended
 aluminum handle
 6 1/2" (16.5cm)

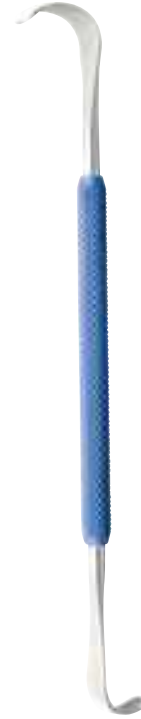

Freeman Flap Retractors

96-4170*
 1/2" (1.3cm) blade
 8" (20cm)

96-4175
 1" (2.5cm) blade
 8" (20cm)



Tebbetts Skin Retractor

96-3920
 16mm wide
 6" (15cm)



Maxwell Flap Retractors

96-4110*
4 prongs
7/8" (2.2cm)
4" (10cm)

96-4112
4 prongs
1 1/2" (3.8cm)
4" (10cm)



Bear Claw Retractors

96-4120
3 prongs
4 3/4" (12cm)

96-4125*
5 prongs
4 3/4" (12cm)



Freeman Rake Retractors

96-4101
4 prongs
3/8" (1cm)
6" (15cm)

96-4102*
4 prongs
7/8" (2.2cm)
7" (18cm)

96-4099
4 in line prongs
7/8" (2.2cm)
7" (18cm)

96-4100
4 prongs
1 1/2" (3.8cm)
7" (18cm)

96-4098
4 in line prongs
1 1/2" (3.8cm)
7" (18cm)



Freeman Facelift Retractor

96-4090*
Adamson model
37mm width
7" (18cm)



Lift Retractors

96-4130*
concave 7 prong rake
7" (18cm)

96-4131
convex 7 prong rake
7" (18cm)



Yancoskie Abdominoplasty Retractor

96-4135*
6 prongs, sharp
7½" (19cm)



Berens Mastectomy Skin Flap Retractor

96-4095*
2 sharp hooks
8" (20cm)



Beckman-Weitlaner Retractors with Hinged Arms 3x4 Prongs

18-3070
sharp
5½" (14cm)

18-3071
blunt
5½" (14cm)

18-3075
sharp
6½" (16.5cm)

18-3076
blunt
6½" (16.5cm)

18-3082*
sharp
8" (20cm)

18-3083
blunt
8" (20cm)



Tebbetts-Style Retractor with Teeth

Optional UA2550 LightMat
may be used
(see pages 24 and 25)

- 96-4305
16mm x 80mm blade
- 96-4310*
25mm x 100mm blade
- 96-4315
25mm x 120mm blade
- 96-4320
30mm x 120mm blade
- 96-4325
25mm x 150mm blade
- 96-4330
30mm x 150mm blade



**Wylie Renal Vein Retractors
1 3/4" (30cm)**

- 18-2071*
1 x 4"
(2.5 x 10cm)
- 18-2072
1 x 7"
(2.5 x 18cm)



Tebbetts Fiber Optic Retractors

WITH TEETH

- 96-4240*
25mm x 100mm blade
- 96-4246
25mm x 120mm blade
- 96-4247
30mm x 120mm blade
- 96-4248
25mm x 150mm blade
- 96-4250
30mm x 150mm blade
- 96-4255
30mm x 180mm blade

BLUNT (NO TEETH)

- 96-4260
25mm x 100mm blade
- 96-4266
25mm x 120mm blade
- 96-4267
30mm x 120mm blade
- 96-4268
25mm x 150mm blade
- 96-4270
30mm x 150mm blade
- 96-4272
36mm x 150mm blade



Roux Retractors

18-1060*
set of 3

18-1061
small #1
20 x 28mm
($\frac{3}{4}$ x $1\frac{1}{8}$ "")
5 $\frac{1}{2}$ " (14cm)

18-1062
medium #2
26 x 23mm
(1 x $\frac{7}{8}$ "")
6" (15cm)

18-1063
large #3
29 x 29mm
($1\frac{1}{8}$ x $1\frac{1}{8}$ "")
6 $\frac{1}{2}$ " (16.5cm)



Army Navy Retractor

18-1055*
set of 2
8 $\frac{3}{4}$ " (21cm)



Hibbs Retractors

18-2080*
set of 2
(18-2081 & 18-2082)

18-2081
#1 only
1 x 3"
(2.5 x 7.6cm)
9" (23cm)

18-2082
#2 only
1 x $3\frac{1}{4}$ "
(2.5 x 8.3cm)
9 $\frac{1}{2}$ " (24cm)

18-2083
1 x 4"
(2.5 x 10cm)
9 $\frac{1}{2}$ " (24cm)



Richardson-Eastman Retractors

18-2050*
set of 2

18-2051
small
10 $\frac{1}{4}$ " (26cm)

18-2052
large
11" (28cm)



Deaver Retractors

18-2054
10mm (3/8")
8" (20cm)

18-2055*
17mm (1 1/16")
8" (20cm)

18-2056
25mm (1")
8" (20cm)



**Deaver Retractors
Hollow Grip Handle**

18-2200
1 x 10"
(2.5 x 25.4cm)

18-2206
2 1/2 x 14 1/2"
(6.4 x 36.8cm)

18-2202
1 x 12"
(2.5 x 30.5cm)

18-2212
3 x 12"
(7.6 x 30.5cm)

18-2204*
1 x 13"
(2.5 x 33cm)

18-2214
4 x 12"
(10 x 30.5cm)

18-2208
1 1/2 x 12"
(3.8 x 30.5cm)

18-2210
2 x 12"
(5 x 30.5cm)



Deaver Retractors

18-2061*
#000
3/4" (1.9cm) wide
7" (18cm)

18-2066
#2 1/2
1" (2.5cm) wide
13 3/4" (35cm)

18-2062
#00
7/8" (2.2cm) wide
8 1/4" (21cm)

18-2067
#3
1 1/2" (3.8cm) wide
12" (30.5cm)

18-2063
#0
1" (2.5cm) wide
9" (23cm)

18-2068
#4
2" (5cm) wide
12" (30.5cm)

18-2073
#0-1
1" (2.5cm) wide
10" (25.4cm)

18-2069
#5
3" (7.6cm) wide
12" (30.5cm)

18-2064
#1
1" (2.5cm) wide
12" (30.5cm)

18-2070
#6
4" (10cm) wide
11 3/4" (30cm)

18-2065
#2
1" (2.5cm) wide
13" (33cm)



Harrington Baby Retractor

18-2074*
1 x 2 3/4" (2.5 x 7cm)
10" (25.4cm)



BOSS™ Precision Caliper

80-2418*
fine angled tips
5" (13cm)



Cook County Breast Marker

96-4690*
areola marker
4 sizes: 40mm, 44mm, 48mm, 52mm



Freeman Circular Breast Markers

96-4698
34mm diameter

96-4699
36mm diameter

96-4700*
38mm diameter

96-4702
40mm diameter

96-4705
42mm diameter

96-4710
45mm diameter

96-4715
50mm diameter



McKissock Keyhole Markers, Semi-malleable

96-4750*
38mm diameter

96-4755
42mm diameter

96-4760
45mm diameter



**Endo-Approach
Forehead Dissector**

96-5578*
straight shaft
9½" (24cm)



**Endo-Approach
Forehead Dissector**

96-5579*
slightly curved shaft
rectangular tip
9½" (24cm)



**Endo-Approach
Forehead Dissector**

96-5577*
strongly curved shaft
flat oval shaped tip
10½" (26.5cm)



**Endo-Approach
Forehead "T" Dissector**

96-5572*
straight shaft
flat oval tip
9¾" (25cm)



**Endo-Approach
Forehead
Dissector**

96-5570*
strongly curved shaft
thin rectangular tip
11" (28cm)



**Endo-Approach
Forehead A/M
Dissector**

96-5574*
strongly curved shaft
thin rectangular tip
curved down
10" (25.4cm)



**Endo-Approach
Forehead Spreader**

96-5573*
strongly curved shaft
tip curved up
10³/₄" (26cm)



**Endo-Approach
Forehead Flap
Dissector**

96-5575*
very slightly curved
shaft & tip
9³/₄" (25cm)



**Endo-Approach
Elevator**

96-5576*
straight shaft
slightly curved
tapered tip
8³/₄" (22.5cm)



**Endo-Approach
Dissector**

96-5571*
multiple curves in shaft
rounded tapered tip
9" (23cm)



**Endo-Approach
Forehead Protector**

96-5580*
left flat shaft
90° bent tip
6³/₄" (17cm)



**Endo-Approach
Forehead Protector**

96-5581*
right flat shaft
90° bent tip
6³/₄" (17cm)



**Endo-Approach
Forehead Elevator**

96-5590*
flat tip with
rounded edges
half curved
9¼" (23.5cm)



**Endo-Approach
Forehead Elevators**

96-5596
straight
flat elevator
with rounded edges
9¼" (23.5cm)

96-5598*
quarter curved
flat elevator
with rounded edges
9¼" (23.5cm)

96-5591
half curved
flat elevator
with rounded edges
9¼" (23.5cm)

96-5599
full curved
flat elevator
with rounded edges
9¼" (23.5cm)



**Endo-Approach
Forehead Dissector**

96-5592*
half curved
flat oval tapered tip
sharp
9¼" (23.5cm)



**Endo-Approach
Forehead Dissector**

96-5593*
half curved shaft
flat square tip
tapered at edge for sharp
or blunt dissection
9¼" (23.5cm)



**Endo-Approach
Forehead Hook**

96-5594*
half curved shaft
fine tapered hook
90° angle
9¼" (23.5cm)



**Endo-Approach
Forehead Knife Handle**

96-5595*
round handle
long shaft
9" (23cm)



**Endo-Approach Forehead Punches,
Insulated Shaft**

96-5603
angled right
sharp scooped jaw
5" (13cm)

96-5588*
angled left
sharp scooped jaw
5" (13cm)



**Endo-Approach Forehead Grasp Forceps,
Insulated Shaft**

96-5604
angled right
atraumatic jaw
with grasping teeth
5" (13cm)

96-5589*
angled left
atraumatic jaw
with grasping teeth
5" (13cm)

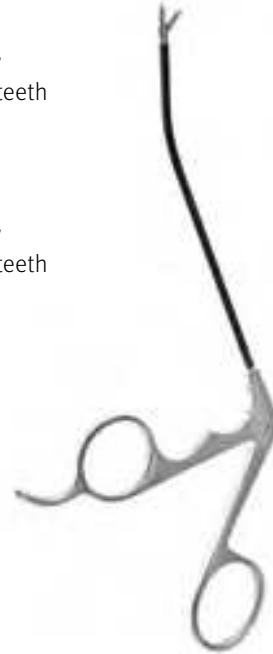

**Endo-Approach Forehead Scissors,
Insulated Shaft**

96-5587
straight
hook type serrated tip
5" (12.5cm)

96-5585*
curved down
hook type serrated tip
5" (12.5cm)

96-5584
curved right
hook type serrated tip
5" (12.5cm)

96-5586
curved left
hook type serrated tip
5" (12.5cm)

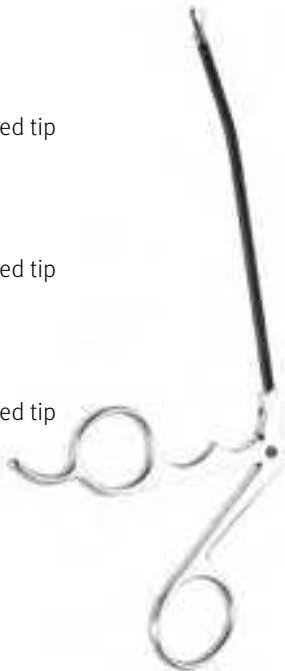

**Fox Dermal Curettes
Round Heads
5 1/2" (14cm)**

96-8010*
1mm diameter

96-8011
2mm diameter

96-8012
3mm diameter

96-8013
4mm diameter

96-8014
5mm diameter

96-8015
6mm diameter



**Sinus Sickle Knives
7 1/2" (19cm)**

93-5580
straight, sharp
adult



93-5582
straight, blunt
adult



93-5584*
right, sharp
adult

93-5585
left, sharp
adult



Ball End Elevator

93-0415*
double-ended
curved
7½" (19cm)



Goldman Displacer Septum Elevator

93-0475*
heavy blade
tapered blade
7¾" (18.7cm)



Hajek-Ballenger Elevator

93-0425*
7⅝" (19.4cm)



Cottle Septum Elevator

93-0476*
double-ended
8½" (21.6cm)



Boies Nasal Fracture Elevator

93-0470*
heavy shaft
blunt edges
7¾" (19.5cm)



**Gorney Suction Elevators
8½" (21.6cm)**

93-0485*
black
3mm tip

93-0486
black
angled 45°



**Converse Osteotomes
7" (18cm)**

- 93-0185*
2mm ($\frac{1}{16}$ "
- 93-0186
4mm ($\frac{5}{32}$ "
- 93-0187
6mm ($\frac{1}{4}$ "
- 93-0188
8mm ($\frac{5}{16}$ "
- 93-0189
10mm ($\frac{3}{8}$ "
- 93-0184
12mm ($\frac{1}{2}$ "



**Rubin Osteotomes
6 1/4" (16cm)**

- 93-0105*
10mm ($\frac{3}{8}$ "
8mm ($\frac{5}{16}$ " cutting edge
- 93-0106
12mm ($\frac{1}{2}$ "
10mm ($\frac{3}{8}$ " cutting edge
- 93-0110
14mm ($\frac{9}{16}$ "
12mm ($\frac{1}{2}$ " cutting edge
- 93-0115
16mm ($\frac{5}{8}$ "
14mm ($\frac{9}{16}$ " cutting edge



**Cinelli Osteotomes
6 1/8" (15.6cm)**

- 93-0170
double guard
10mm ($\frac{3}{8}$ "
- 93-0172*
double guard
12mm ($\frac{1}{2}$ "
- 93-0174
double guard
14mm ($\frac{9}{16}$ "
- 93-0176
double guard
16mm ($\frac{5}{8}$ "



**Cinelli
Osteotome**

- 93-0179*
curved
double guard
10mm ($\frac{3}{8}$ "
6 1/8" (15.6cm)



**Silver
Osteotomes
7 1/4" (18.5cm)**

- 93-0160*
straight
5mm ($\frac{3}{16}$ "
- 93-0161
curved right
5mm ($\frac{3}{16}$ "
- 93-0162
curved left
5mm ($\frac{3}{16}$ "



**Anderson Neivert
Osteotomes
8" (20cm)**

- 93-0145*
curved right
5mm ($\frac{3}{16}$ "
- 93-0146
curved left
5mm ($\frac{3}{16}$ "



**Neivert
Osteotomes**

- 93-0150*
single guard
4mm ($\frac{5}{32}$ "
8" (20cm)



Ballenger Chisels
6" (15cm)
V-shaped Edge

93-0060
 2mm ($\frac{1}{16}$ ")

93-0062
 4mm ($\frac{5}{32}$ ")

93-0064
 6mm ($\frac{1}{4}$ ")

93-0066*
 8mm ($\frac{5}{16}$ ")



Cottle Nasal Chisels
7 1/4" (18.5cm)

93-0126
 curved
 4mm ($\frac{5}{32}$ ")

93-0128*
 curved
 6mm ($\frac{1}{4}$ ")



Converse Guard Chisels
7 1/2" (19cm)

93-0130
 curved right
 6mm ($\frac{1}{4}$ ")

93-0131*
 curved left
 6mm ($\frac{1}{4}$ ")



Beyer Rongeurs

26-1020*
2mm bite
7" (18cm)

26-1021
3mm bite
7" (18cm)

26-1022
4mm bite
7" (18cm)



**Mini Ruskin Rongeurs Double Action
6" (15cm)**

26-1054
straight
2mm jaw

26-1055*
curved
2mm jaw

26-1056
straight
3mm jaw

26-1057
curved
3mm jaw

26-1057-4
curved
4mm jaw



Friedman Rongeurs

26-1004*
curved bite
2.5mm bite
5¼" (13.5cm)



Blumenthal Rongeurs

26-0950*
light curve, 3.5mm jaw
6" (15cm)

26-0951
strong curve, 3.5mm jaw
6" (15cm)

26-0952
jaw angled 90°, 3.5mm jaw
6" (15cm)

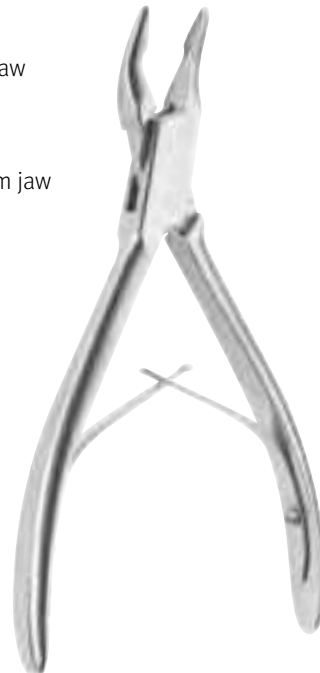

Basic Plastic Surgery

1	10-5200	Yankauer Suction Tube, 11½"	
2	10-0003	Knife Handle, #3	
2	10-0007	Knife Handle, #7	
2	14-1201	Mosquito Forceps, straight	<i>pg 14</i>
2	14-1202	Mosquito Forceps, curved	<i>pg 14</i>
2	14-1250	Crile Forceps, 5½", straight	<i>pg 14</i>
4	14-5508	Backhaus Towel Clamp, 3½"	
2	16-1110	Sponge Forceps, 9½", straight, serrated	
1	18-1055	US Army Retractor, pair	<i>pg 30</i>
1	18-2200	Deaver Retractor, 1" x 10"	<i>pg 31</i>
1	18-3050	Weitlaner Retractor, Sharp, 2x3, 4"	
1	18-5050	Joseph Skin Hook, 1 sharp prong, 6¼"	<i>pg 22</i>
1	18-5056	Joseph Skin Hook, 2 sharp prongs, 6¼"	<i>pg 22</i>
1	18-5090	Senn Retractor, 6¼", sharp	<i>pg 22</i>
1	18-5091	Senn Retractor, 6¼", blunt	<i>pg 22</i>
2	30-1010	Allis Tissue Forceps, 4x5, 6"	
1	50-1405	Webster Needle Holder, 4½"	<i>pg 18</i>
1	50-1410	Halsey Needle Holder, 5"	<i>pg 18</i>
1	50-1500	Adson Dressing Forceps, 4¾"	<i>pg 17</i>

1	50-1503	Adson Tissue Forceps, 1x2, 4¾"	<i>pg 17</i>
1	50-1506	Adson-Brown Tissue Forceps, 4¾"	<i>pg 17</i>
1	50-1711	Metzenbaum Scissors, 5¾", curved	<i>pg 6</i>
1	50-1750	Metzenbaum Scissors, 7", curved	<i>pg 6</i>
1	50-1885	Gorney Scissors, 8", curved	<i>pg 10</i>
1	50-2407	Crile-Wood Needle Holder, 7"	<i>pg 19</i>
1	50-3005	Iris Scissors, 4½", curved	<i>pg 8</i>
1	50-3006	Iris Scissors, 4½", straight	<i>pg 8</i>
1	50-3045	Par Scissors, 4½", curved	<i>pg 11</i>
1	50-3061	Joseph Scissors, 5½", curved	<i>pg 12</i>
1	51-1810	Mayo Scissors, 5½", straight	
1	51-1830	Mayo Scissors, 6¾", straight	<i>pg 7</i>
1	56-9016	Stevens Scissors, 4½", curved	<i>pg 8</i>
2	74-5012	Frazier Suction Tube, Angled, 4½", 8Fr	
1	78-1880	Ruler, Flexible, 6"	
1	93-0425	Hajek Ballenger Elevator, 7⅝"	<i>pg 37</i>
1	93-1360	Kasden Thin Bladed Retractor	<i>pg 26</i>
1	96-5121	Kilner Undermining Scissors, 6", curved	<i>pg 12</i>

Facelift

1	10-0003	Knife Handle, #3	
1	10-0007	Knife Handle, #7	
1	14-1417	Adson Artery Forceps, 7¼", curved	<i>pg 14</i>
2	18-2056	Deaver Retractor, 25mm, 8"	<i>pg 31</i>
1	18-5050	Joseph Skin Hook, 1 sharp prong, 6¼"	<i>pg 22</i>
1	18-5064	Joseph Skin Hook, 2 sharp prongs, 6¼"	<i>pg 22</i>
1	18-5067	Kleinert Kutz Hook, 1 sharp prong, 6¼"	<i>pg 22</i>
1	50-1500	Adson Dressing Forceps, 4¾"	<i>pg 17</i>
1	50-1503	Adson Tissue Forceps, 1x2, 4¾"	<i>pg 17</i>
1	50-1507	Adson-Brown Tissue Forceps, 6"	<i>pg 17</i>
1	50-1525	Cushing Bayonet Forceps, 7"	<i>pg 16</i>

1	50-2406	Crile-Wood Needle Holder, 6"	<i>pg 19</i>
1	50-2436	Mayo-Hegar Needle Holder, 6"	<i>pg 19</i>
1	50-2470	Ryder Needle Holder, 6"	<i>pg 19</i>
1	56-9016	Stevens Scissors, 4½", curved	<i>pg 8</i>
1	56-9205	Gorney Facelift Scissor, 7½", straight	<i>pg 10</i>
1	56-9207	Gorney Facelift Scissor, 7½", curved	<i>pg 10</i>
1	56-9230	Gorney Platysma Scissor, 9", straight	<i>pg 10</i>
1	56-9232	Gorney Platysma Scissor, 9", curved	<i>pg 10</i>
2	96-4100	Freeman Rake Retractor, 1½"	<i>pg 27</i>
2	96-4102	Freeman Rake Retractor, 7/8"	<i>pg 27</i>
1	96-4180	D'Assumpcao Facelift Marker, 6¼"	<i>pg 15</i>

Breast Augmentation

1	10-0003	Knife Handle, #3	
1	10-0007	Knife Handle, #7	
2	14-1201	Mosquito Forceps, straight	<i>pg 14</i>
2	14-1225	Hartman Mosquito Forceps, straight	
2	14-1251	Crile Forceps, 5½", curved	<i>pg 14</i>
2	14-1387	Kocher Forceps, 5", straight	
4	14-5508	Backhaus Towel Clamp, 3½"	
3	18-0957	Ribbon Retractor, ½", 8"	<i>pg 26</i>
1	18-1055	US Army Retractor, pair	<i>pg 30</i>
1	18-2210	Deaver Retractor, 2" x 12"	<i>pg 31</i>
1	18-2212	Deaver Retractor, 3" x 12"	<i>pg 31</i>
1	18-5056	Joseph Skin Hook, 2 sharp prongs, 6¼"	<i>pg 22</i>
1	18-5061	Joseph Skin Hook, 2 sharp prongs, 6¼"	<i>pg 22</i>
2	18-5090	Senn Retractor, 6¼", sharp	<i>pg 22</i>
2	30-1010	Allis Tissue Forceps, 4x5, 6"	
1	50-1160	Olsen-Hegar Needle Holder, 5½"	<i>pg 18</i>
1	50-1322	Tissue Forceps, 1x2, 5¾"	<i>pg 16</i>
1	50-1405	Webster Needle Holder, 4½"	<i>pg 18</i>
1	50-1500	Adson Dressing Forceps, 4¾"	<i>pg 17</i>
1	50-1503	Adson Tissue Forceps, 1x2, 4¾"	<i>pg 17</i>
1	50-1750	Metzenbaum Scissors, 7", curved	<i>pg 6</i>
1	50-2436	Mayo-Hegar Needle Holder, 6"	<i>pg 19</i>
1	50-2525	Heaney Needle Holder, 8"	<i>pg 19</i>
1	50-3005	Iris Scissors, 4½", curved	<i>pg 8</i>
1	50-3006	Iris Scissors, 4½", straight	<i>pg 8</i>
1	50-3046	Par Scissors, 4½", serrated, curved	<i>pg 11</i>
1	51-1830	Mayo Scissors, 6¾", straight	<i>pg 7</i>
1	56-9015	Stevens Scissors, 4½", straight	<i>pg 8</i>
1	56-9016	Stevens Scissors, 4½", curved	<i>pg 8</i>
1	74-5012	Frazier Suction Tube, Angled, 4½", 8Fr	
1	95-2050	Schmidt Tonsil Forceps, 7¼", half curve	

Mastectomy

1	10-0003	Knife Handle, #3	
1	10-0007	Knife Handle, #7	
2	14-1202	Mosquito Forceps, curved	<i>pg 14</i>
1	14-1417	Adson Artery Forceps, 7¼", curved	<i>pg 14</i>
1	14-1429	Adson Artery Forceps, 8¼", curved	
1	14-1495	Right Angle Mixer Forceps, 5¼"	
1	14-1498	Right Angle Mixer Forceps, 7¼"	
2	14-5817	Non-Penetrating Towel Clamp, 5½"	
1	18-1055	US Army Retractor, pair	<i>pg 30</i>
2	18-5095	Ragnell Retractor, 6"	
1	50-1323	Tissue Forceps, 1x2, 6¼"	<i>pg 16</i>
1	50-1503	Adson Tissue Forceps, 1x2, 4¾"	<i>pg 17</i>
1	50-2406	Crile-Wood Needle Holder, 6"	<i>pg 19</i>
1	56-9060	Metzenbaum Scissors, 5½", curved	<i>pg 6</i>
1	56-9061	Metzenbaum Scissors, 7", curved	<i>pg 6</i>
1	56-9114	Jabaley Scissors, 5", straight	<i>pg 11</i>
1	56-9116	Jabaley Scissors, 5", curved	<i>pg 11</i>
1	56-9212	Kaye Facelift Scissor, 5¾", curved	<i>pg 9</i>
1	56-9213	Kaye Facelift Scissor 7", curved	<i>pg 9</i>
1	56-9232	Gorney Platysma Scissor, 9", curved	<i>pg 10</i>
1	65-2231	Debakey Vascular Tissue Forceps, 7¾"	
1	65-2232	Debakey Vascular Tissue Forceps, 9½"	
1	95-2050	Schmidt Tonsil Forceps, 7¼", half curve	
1	96-4110	Maxwell Flap Retractor, 22mm, 4"	<i>pg 27</i>
1	96-4112	Maxwell Flap Retractor, 38mm, 4"	<i>pg 27</i>
1	96-4320	Tebbetts Retractor, W/ Teeth, 30mm X 120mm Blade	<i>pg 29</i>
1	96-4325	Tebbetts Retractor, W/ Teeth, 5mm X 150mm Blade	<i>pg 29</i>

Abdominoplasty

1	10-0003	Knife Handle, #7	
4	14-1202	Mosquito Forceps, curved	<i>pg 14</i>
1	18-1055	US Army Retractor, pair	<i>pg 30</i>
2	30-1015	Allis Tissue Forceps, 5x6, 6"	
1	50-1323	Tissue Forceps, 1x2, 6¼"	<i>pg 16</i>
1	50-1405	Webster Needle Holder, 4½"	<i>pg 18</i>
2	50-1503	Adson Tissue Forceps, 1x2, 4¾"	<i>pg 17</i>
1	50-1506	Adson-Brown Tissue Forceps, 4¾"	<i>pg 17</i>
2	50-2436	Mayo-Hegar Needle Holder, 6"	<i>pg 19</i>
1	50-3006	Iris Scissors, 4½", straight	<i>pg 8</i>
1	51-1830	Mayo Scissors, 6¾", straight	<i>pg 7</i>
1	56-9016	Stevens Scissors, 4½", curved	<i>pg 8</i>
1	56-9060	Metzenbaum Scissors, 5½", curved	<i>pg 6</i>
1	56-9232	Gorney Platysma Scissor, 9", curved	<i>pg 10</i>
2	73-1060	Meyerding Retractor, 2" x 3", 9½"	
1	78-1880	Ruler, Flexible, 6"	
2	93-0315	Cottle Joseph Hook, 5¾", 2 sharp prongs	<i>pg 22</i>
3	95-3060	Lahey Traction Fcp, 3x3 Prong, 6"	<i>pg 15</i>
1	96-4098	Freeman Rake Retractor, 4 inline prongs, 1½"	<i>pg 27</i>
1	96-4099	Freeman Rake Retractor, 4 inline prongs, 7/8"	<i>pg 27</i>
1	96-4135	Yancoskle Retractor 6 inline prongs	<i>pg 28</i>
1	96-4198	Lockwood Abdominal Demarcator, 12¾"	<i>pg 15</i>
1	95-2050	Schmidt Tonsil Forceps, 7¼", half curve	
1	96-4110	Maxwell Flap Retractor, 22mm, 4"	<i>pg 27</i>
1	96-4112	Maxwell Flap Retractor, 38mm, 4"	<i>pg 27</i>
1	96-4320	Tebbetts Retractor, W/ Teeth, 30mm X 120mm Blade	<i>pg 29</i>
1	96-4325	Tebbetts Retractor, W/ Teeth, 25mm X 150mm Blade	<i>pg 29</i>



All rights reserved. Technical alterations are possible. This leaflet may be used for no other purposes than offering, buying and selling of our products. No part may be copied or reproduced in any form. In the case of misuse, we retain the rights to recall our catalogues and price lists and to take legal actions.